

Viewing Instructions

Buttons located at top and/or bottom of digital publication



FULL SCREEN MODE
(DESKTOP / LAPTOP)



SEARCH for words or phrases in this issue



HOME
jump to www.bcadigital.com



TABLE OF CONTENTS



Download to read on tablets and phones.
Download to read offline. Download to print.

ZOOM IN & OUT: Mouse-- Using the scroll wheel on your mouse or clicking will increase or decrease the zoom of the page. To print, download the PDF. For best viewing experience, we recommend using Firefox, Chrome, or Safari instead of Internet Explorer on desktops. If you experience trouble displaying the digital edition, updating your browser might help.

Digital Edition Copyright Notice

The content contained in this digital edition ("Digital Material"), as well as its selection and arrangement, is owned by Penton Media, Inc. and its affiliated companies, licensors, and suppliers, and is protected by their respective copyright, trademark and other proprietary rights.

Upon payment of the subscription price, if applicable, you are hereby authorized to view, download, copy, and print Digital Material solely for your own personal, non-commercial use, provided that by doing any of the foregoing, you acknowledge that (i) you do not and will not acquire any ownership rights of any kind in the Digital Material or any portion thereof, (ii) you must preserve all copyright and other proprietary notices included in any downloaded Digital Material, and (iii) you must comply in all respects with the use restrictions set forth below and in the Penton Privacy Policy and the Penton Terms of Use (the "Use Restrictions"), each of which is hereby incorporated by reference. Any use not in accordance with, and any failure to comply fully with, the Use Restrictions is expressly prohibited by law, and may result in severe civil and criminal penalties. Violators will be prosecuted to the maximum possible extent.

You may not modify, publish, license, transmit (including by way of email, facsimile or other electronic means), transfer, sell, reproduce (including by copying or posting on any network computer), create derivative works from, display, store, or in any way exploit, broadcast, disseminate or distribute, in any format or media of any kind, any of the Digital Material, in whole or in part, without the express prior written consent of Penton Media, Inc. To request content for commercial use or Penton's approval of any other restricted activity described above, please contact the Reprints Department at (877) 652-5295. Without in any way limiting the foregoing, you may not use spiders, robots, data mining techniques or other automated techniques to catalog, download or otherwise reproduce, store or distribute any Digital Material.

NEITHER PENTON NOR ANY THIRD PARTY CONTENT PROVIDER OR THEIR AGENTS SHALL BE LIABLE FOR ANY ACT, DIRECT OR INDIRECT, INCIDENTAL, SPECIAL OR CONSEQUENTIAL DAMAGES ARISING OUT OF THE USE OF OR ACCESS TO ANY DIGITAL MATERIAL, AND/OR ANY INFORMATION CONTAINED THEREIN.

SEPTEMBER 2019 \$10.00 www.bcadigital.com

BCA

Business & Commercial Aviation

Voila, Le Bourget

More than a century old, the storied
Parisian airport is now Europe's
premier business aviation facility

ALSO IN THIS ISSUE

Fixated on Landing
Is Simulator
Training Sufficient?

My Gulfstream
G500 Initial

AVIATION WEEK
NETWORK



A General Dynamics Company

ELEVATE YOUR EXPECTATIONS

We are more than the sum of our parts. Harness the power of the largest and fastest growing Customer Support network in the industry. We provide the most responsive 24/7/365 customer service. No one knows your Gulfstream better than our nearly 5,000-person-strong support team.

THE ART OF EXCELLENCE™



Keep up with all the news and blogs from BCA editors "like" us on facebook facebook.com/avweekbca and follow us on twitter twitter.com/avweekbca



56

Features

20 **Fixated on Landing**
Richard N. Aarons
The dangers of ignoring SOPs

32 **My Gulfstream G500 Initial**
James Albright
Reinventing how we train

38 **High-Altitude Haute Cuisine**
Fred George
Providing fine dining aloft isn't a trivial or inexpensive task

42 **Voila, Le Bourget**
David Esler
More than a century old, the storied Parisian airport is now a premier business aviation facility

48 **Urban Upheaval**
Patrick Veillette
The revolution could arrive sooner than expected

56 **All About Jet Blast**
Patrick Veillette
A potential hazard on ramps, taxiways and runways



42

28 **Is Sim Training Sufficient?**
Fred George
What you don't learn at the schoolhouse



38

9 Intelligence

Edited by William Garvey, Jessica A. Salerno and Molly McMillin

Tamarack Receives New Funding

Dickson Sworn in as FAA Administrator

Pilot Shortage Problem a Bankable Opportunity?

Honda Aircraft Expands in Greensboro

ICON to Cut Hundreds of Jobs

Gulfstream Delivers First G600

Signature Acquires IAM Jet Center



Fast Five With John McKenna, Chairman, Recreational Aviation Foundation



32



Digital Extras



Tap this icon in articles in the digital edition of BCA for exclusive features. If you have not signed up to receive your digital subscription, go to AviationWeek.com/bcacustomers

For the latest developments, go to www.bcadigital.com

Selected articles from BCA and The Weekly of Business Aviation, as well as breaking news stories and daily news updates

COVER

Photo of the Paris LeBourget Airport supplied by iStockPhoto

Departments

7 Viewpoint

8 Readers' Feedback

24 Accidents in Brief

64 Point of Law

66 20/Twenty

68 On Duty

71 Advertiser's Index

70 Products & Services

72 BCA 50 Years Ago

67 Marketplace



Get Key Developments and Analysis of the Business Aviation Market

Delivered right into your inbox, The Weekly of Business Aviation will provide you the data and intelligence you need to stay informed of this complex market.

Visit aviationweek.com/wba to download a complimentary edition

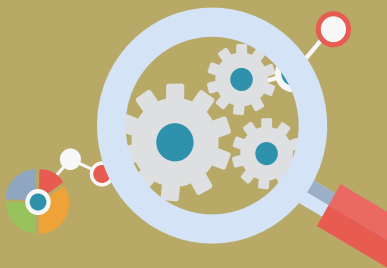

EMPOWER YOUR WORKFORCE WITH A GROUP OR SITE LICENSE

For more information visit:
aviationweek.com/BAGroups



Editor-in-Chief William Garvey — william.garvey@informa.com
Executive Editor Jessica A. Salerno — jessica.salerno@informa.com
Senior Editor/Chief Pilot Fred George — fred.george@informa.com
Safety Editor Richard N. Aarons — bcasafety@gmail.com
International Operations/Features Editor David Esler — david.esler@comcast.net
News Editor Molly McMillin — molly.mcmillin@informa.com
Art Direction Lisa Caputo — lcaputo@aviationweek.com
Art Department Colin Throm — colin.throm@aviationweek.com
Associate Producer Theresa Petruso — theresa.c.petruso@informa.com
Copy Editor Scot Greenan — sgman124@gmail.com
Contributors James Albright — james@code7700.com
 Mal Gormley — malgormley@gmail.com
 Kent S. Jackson — kjackson@jetlaw.com
 Ross Detwiler — rossdetwiler.com
 Patrick Veillette, Ph.D. — jumpsaway@aol.com
 Ringston Media — info@ringstonmedia.com
 520 Folly Rd., Ste. 238, Charleston, S.C.
 (520) 638-8721 • (843) 718-2458

Editorial Offices

Publisher Frank Craven — frank.craven@informa.com
 Phone: (913) 967-1729
Managing Director, Business Aviation Intelligence/Data Services Anne McMahon — anne.mcmahon@aviationweek.com
 Phone: (646) 291-6353
Director of Sales, Business Aviation Elizabeth Zlitni — elizabeth.zlitni@informa.com
 Phone: (913) 967-1348
Advertising Production Coordinator Kara Walby — kara.walby@informa.com
 Informa, 9800 Metcalf Ave., Overland Park, KS 66212
 Phone: (913) 967-7476 • Fax: (913) 514-7303
Senior Audience Development Manager Tyler Motsinger — tyler.motsinger@informa.com
 Phone: (913) 967-1623
Head of Business Aviation Fleet Data Nigel Prevett — nigel.prevett@aviationweek.com
 Phone: 407-314 7403
Head of Valuations, Business Aviation Chris Reynolds — chris.reynolds@informa.com
 Phone: (913) 967-1956
Subscription Information **BCA Customer Service:**
 (800) 525-5003; +1 (847) 9147
 Email: bca@omeda.com
Manage Your Subscription:
aviationweek.com/bcasubscribers
Wright's Media
 Nick Iademarco — informa@wrightsmedia.com
 Phone: (877) 652-5295 • Fax: (281) 419-5712

Reprints

President, Aviation Week Network Gregory Hamilton — hamilton@aviationweek.com
Managing Director—Civil Aviation Administrative Offices Iain Blackhall — iain.blackhall@aviationweek.com
 605 3rd Ave., New York, N.Y. 10158

By Informa Markets

BCA - Business & Commercial Aviation (ISSN 0191-4642) is published monthly by Informa Markets, a trading division of Informa PLC, 9800 Metcalf Ave., Overland Park, KS 66212-2216. Also the publisher of *Aviation Daily*, *Aviation Week & Space Technology*, *The Weekly of Business Aviation* and *World Aerospace Database*. Single copy: Current and back issues, \$10.00 Domestic/Canada/Mexico. \$15.00 International. Subscriptions (1 year, 12 issues): United States and Canada, \$59.00; all other countries, \$79.00. For single copies/back copies call Customer Service at (800) 525-5003 in the United States and (847) 763-9147 for all other countries. Periodicals postage paid at Kansas City, MO and additional mailing offices. Registered for GST as GST #R126431964. Canada Post Publication Mail Agreement Number 40026880. Editorial contributions should be addressed to BCA, 520 Folly Rd., Ste. 238, Charleston, S.C. 29412, editorial address and must be accompanied by return postage. Publisher assumes no responsibility for safety of artwork, photographs or manuscripts. USPS 503-450.

Printed in the U.S.A.

Permissions: Material in this publication may not be reproduced, stored in a retrieval system, or transmitted in any form or by any means (electronic, mechanical, photocopying, recording or otherwise) without the prior written permission of the publisher.

Postmaster: Send address corrections to BCA - Business & Commercial Aviation, P.O. Box 1174 Skokie, IL 60076-8174. (Present subscribers include label)

© Copyright 2019 by Informa Markets, a trading division of Informa PLC. All rights reserved.



ASMCORP

ASMCORP has become the fastest growing flight-support and ground handling company in the region. Our commitment to provide you with an unmatched combination of flawless service, local expertise and value has made us the preferred choice in Latin America. We have also become the largest Fuel provider in Mexico and one of the most important in the region.

Having your own network of agents in the region provides you dependable, personalized service at every location. Making sure that your passengers and crew are met by our agents who are informed and knowledgeable of every detail and specification of your operation to ensure a safe, smooth and quick handling while on the ground.

We take time to inspect every facility within our network to provide a complete list of available services at each location to guarantee you receive an unmatched level of service and support in the regional while on the ground.



OUR SERVICES

- Landing/Overflight Permits
- Flight Planning
- Concierge Services
- Ground Transportation
- Airport Slots
- Security
- Cuba Overflight Permits
- Catering
- Ground Handling

CONTACT US

Cancun, Toluca, Monterrey,
San José del Cabo,
San José Costa Rica (coming soon)
52 818 122 5100
+1-888-322-7559
Ops@asmcorp.com.mx
Web: asmcorp.com.mx

WE HELP AVIATION SALES PROFESSIONALS GENERATE DEALS



AMSTAT PROVIDES INDUSTRY LEADING CORPORATE
AIRCRAFT MARKET & FLEET DATA

- ▶ Jets
- ▶ Turboprops
- ▶ Turbine Helicopters

*In a suite of comprehensive services to meet
every business need*



Information that moves you forward

US 1 877 426 7828 | Int'l +1 732 530 6400 | www.amstatcorp.com



Advertising Sales

Publisher

Frank Craven – frank.craven@informa.com
(202) 517-1061

Director of Sales

Elizabeth Zlitni – elizabeth.zlitni@informa.com
(913) 967-1348

North America Advertising Sales

Pacific Region

Miguel Ornelas – miguel.ornelas@aviationweek.com
(661) 480-7000

Midwest Region

Rob Howlett – rob.howlett@aviationweek.com
(949) 481-4519

Jodi Espinoza – jespinoza@acukwik.com
(913) 967-1651

Eastern Region

Cheryl Mahon – cheryl.mahon@aviationweek.com
(949) 481-4519

Florida, Georgia, South Carolina

Beth Eddy – betheddy@aviationexhibits.com
(561) 279-4646

Canada

David Seaberg – david.seaberg@vicbrownmedia.com
(416) 787-0914

Strategic Account Managers

Tom Davis – tom.davis@aviationweek.com
(469) 854-6717

Matt Holdreith – matt.holdreith@informa.com
(646) 719-0767

FBO Advertising Sales

Jodi Espinoza – jespinoza@acukwik.com
(913) 967-1651

Sara Hellon – sara.hellon@informa.com
(913) 967-1833

Jennifer Shafer-Doyle – jennifer.shafer@informa.com
(913) 967-1833

Worldwide Advertising Sales

Francine Brasseur – francine.brasseur@informa.com
+(617) 649-0411

Michele Markarian – michele.markarian@informa.com
(617) 649-0420

Europe

Robert Springthorpe – robert.springthorpe@aviationweek.co.uk
+44 (0) 207 017 7627

Andrea Prudente – andrea.prudente@aviationweek.com
+44 207 152 4524

Israel

Tamir Eshel – invision@netvision.net.il
+972 (9) 891-1792



High-impact bonus distribution

Look for *BCA* at these upcoming events -

September Issue:

- Air Charter Expo, September 17, London
- MEBA, September 17-18, Morocco

October Issue: NBAA Show Issue!

- Business & General Aviation Conference, October 2, Los Angeles
- NBAA-BACE, October 22-24, Las Vegas



Business & General Aviation Conference

Strategy → Program Updates → Supplier Opportunities

OCTOBER 2, 2019

Jonathan Club
Los Angeles, CA

This Conference is designed for leaders and decision-makers from OEMs to supplier Tiers in the Business & General aviation industry, including strategic planning and business development leaders, supply chain executives, market analysts, investment bankers and financial institutions.

Delegates at the **Business & General Aviation Conference** will meet and interact with industry experts and manufacturers who will provide updates on the state of the industry, recovery trajectories within the market, and technology advancements. Various networking opportunities throughout the Conference will enable you to connect with colleagues, and develop valuable relationships with peers, influential decision makers and even competitors.

The THREE MAIN PILLARS of the Conference are:

Strategy, Program Updates and **Supplier Opportunities**. Knowledge gained from each pillar is actionable — enabling delegates to effectively secure significant and sustainable growth opportunities.

Strategy



Supercharge Your Business Strategy

Delegates at Business & General Aviation Conference engage with top industry analysts who offer their views of the industry, provide forecasts for business planning, long-term strategies around products, consolidation and restructuring, and OEM initiatives.

Program Updates



Grow Your Business or Organization

The Business & General Aviation Conference shows suppliers how to make their mark with top programs and clear the fiscal realities and the deal-making models that contractors are utilizing today. Delegates discover how the supply chain is reshaping itself to create winning positions on major programs.

Supplier Opportunities



Stay Informed and Ahead of the Competition

Discover program breakthroughs and technological innovations as speed and disruption become increasingly important factors. Gain visibility into the processes and systems that enable suppliers and decision makers to reach the highest levels of success.

Topics focus on key components driving the industry:

- Upward trends in business and general aviation
- OEM product strategy and market developments
- Trajectories within the supplier market
- Forecasts within current market

Who benefits from attending?

- Strategic planning and business development leaders
- Supply chain executives and senior decision makers
- Analysts and investment/financial community members
- Information and technology specialists

Sponsorships

Sponsorships enable you to promote your brand, products and/or services on the expansive Aviation Week Network, and on-site throughout the Conference. Customized sponsorships are also available. The earlier you begin your Sponsorship – the more valuable it is! The Aviation Week Network averages more than two million page views per month – that's millions of potential views of your logo if you start today! To become a Sponsor contact Joanna Speed, Managing Director, A&D Conferences at +1-424-465-6501.

 Crafted in Switzerland



PC-24
THE CRYSTAL CLASS



PILATUS

IS THERE A CLOSER AIRPORT? YES, BUT ONLY YOU CAN ACCESS IT!

The world's first Super Versatile Jet takes off! It's simple – you fly business aircraft to save time. The PC-24's outstanding short runway performance enables you to access thousands more airports than traditional business jets. It's simply a time machine – with the PC-24, you'll spend less time driving and more quality time at your destination. Save time too and fly PC-24 – contact us now!

Pilatus Business Aircraft Ltd · USA · +1 303 465 9099 · www.pilatus-aircraft.com



Gold Medal Performers

Opening the door

PAGING THROUGH AVIATION FOR WOMEN MAGAZINE, MY EYES fixed on a photo of a familiar figure from long ago. There, poised in a period Champion spark plug ad below the headline “Dancing in the Sky” stood a pilot, hands on hips, left foot forward, a parachute in back, leather flying cap above and dark sunglasses masking eyes in a somewhat pugnacious visage. Oh, and a yellow Pitts Special with black trim stood behind.

Yup. That’s her.

Before there was a Patty Wagstaff, Svetlana Kapanina, Julie Clark, or any of today’s celebrated women aerobats, there was Mary Gaffaney. Unlike those who followed, she didn’t look the part. She was middle aged, a tad beefy and reserved, a 5 ft., 4 in. matron whom Flying columnist Gordon Baxter suggested, “ought to be cutting out biscuits to win a Pillsbury Bake-Off.”

Although a veteran pilot — she’d been a racer and skywriter — and flight school owner, she hadn’t realized her true aviation calling until meeting a fellow with the key to high-G wonders awaiting aloft: Curtis Pitts and his amazing Pitts Special. When Mary slid into the cockpit of the S-1, she and the aircraft were fused; there had never been any union quite like it.

That Mary had found her medium was soon confirmed by what she achieved: five times Women’s National Aerobatic winner, a gold medalist in the 1970 Women’s World Aerobatic Championship and two years later, the first American to take overall gold in that international competition. The 46-year-old Miamian was the best in the world. Her one disappointment, she confided to me, was that her gender barred her from competing with men. She so wanted to prove she could hold her own and just maybe prevail. Some biscuits, eh?

She voiced that frustration at her Kendall Flying School where I was a student. Though initially ignorant of her fame, I had asked about the hangared Pitts. And while I quickly came to appreciate its owner’s aerial mastery, what I prized especially was her signature in my logbook — entered following my Private check ride with her.

“Congratulations,” she said. “You’re officially a pilot. Ever think of becoming a professional?”

Her question got my imagination soaring. A world-renowned aviator thought I had what it took. I floated home, grinning the whole way. I suspected she posed the same question to each of the hundreds of pilots she’d launched through the years. But all that mattered was she asked it of me.

Over time I got my Commercial and became an aviation

professional, though following a different path than the one Mary had in mind. But it was her enthusiasm, encouragement and example that helped me embrace an aviation vocation. She really was an inspiration and I know many felt similarly.

Which begs the question. When there have been such exemplary aviation figures like Mary among the many of her gender, why has the industry remained so heavily male? I’ve heard the litany of social, academic and economic explanations, and while plausible, I find the degree of their impact difficult to comprehend. After all, women have demonstrated the intellectual and physical prowess, the inventiveness and determination to succeed in every aspect of aerospace, and yet their numbers overall remain modest. The industry needs more of them. Lots more.

Fortunately, there exists an organization — a kind of winged sorority — founded decades after Mary’s heyday, but one she surely would endorse were she still with us. (She “flew west” in December 2017 at age 91.) Women in Aviation International (WAI) provides its members with the information, contacts, opportunities, guidance, encouragement and personal examples so vital to achieving success in aerospace on a wide scale.

Begun modestly as a conference in 1990 by Dr. Peggy Chabrian, a pilot and educator, she clearly understood the need, one confirmed by the steady growth of the organization that evolved. Today, WAI represents 14,000 members — women mostly, but men, too — in chapters around the country and the world. The membership serves the full breadth of aerospace roles from astronauts and business pilots to air traffic controllers, maintenance technicians and, yes, air show performers and journalists — including those behind *Aviation for Women*, WAI’s fine magazine.

That popular annual high-energy conference now draws 4,500 attendees, 150+ exhibitors and lots of industry support, and next year’s March 5-7 gathering in Florida will deliver to members nearly \$1 million in scholarships. WAI is a career launchpad for women who, like Mary Gaffaney, seek the wonders awaiting them aloft.

At the recent Experimental Aircraft Association AirVenture, WAI President Chabrian announced her intention to retire. She can exit with great pride in what she’s accomplished by creating and guiding an organization that has opened the door for so many. By every measure, her gender-focused performance was a gold medal winner, one benefiting all of aviation. **BCA**



Mary Gaffaney



Dr. Peggy Chabrian

Readers' Feedback

High-Level Thanks

I am a long-time subscriber to *BCA* and *Aviation Week* and have written to their editors on a few occasions. I applaud the high level of the articles and technical presentations. Thank you.

Capt. Nat Iyengar
G650 Fleet Technical Pilot
Jet Aviation Business Jets Ltd.
Hong Kong

On a Positive Note

I really enjoyed reading and thank you for your positive article "**Robinson R66: Passion, Performance and Price**" in the **July 2019 BCA (page 34)**. The sidebar article on Frank was also nicely done. All of us at Robinson appreciate your dedication to aviation and providing informative articles for your readers. Please let me know if we can provide any assistance in the future and keep up the good work.

Kurt Robinson
President
Robinson Helicopters
Torrance, California

Real-World Numbers

Regarding **20/Twenty in the July 2019 issue (page 64)**, what criteria are you using?

I have operated both the Citation CJ4 and Lear 45XR and neither can do the leg presented nonstop with zero tailwind without a ridiculous long-range cruise setting. And even then it would be questionable as a "safe" operation concerning fuel margins.

In addition, in a real-world normal operating situation the 45XR would be 7 min. farther downrange ahead of the CJ4 just in the climb to cruise altitude.

And finally, this is a manipulated embellishment to say the least with no weather and performance criteria established to make such a comparison and present it to your readers.

This is an ongoing problem to present to potential principals, but then the reality of it is not what was presented. That puts the burden on flight department managers to deal with the disappointment of the principals. Healthy discussion is quality time.

Andrew Smith
Chief Pilot
Fox Aviation
McAllen, Texas

Editor's Response: Thank you for your insightful letter and we very much appreciate your healthy skepticism of manufacturers' optimized performance numbers. When we compare aircraft performance, as for our 20/Twenty reports, we use the numbers published in *BCA's Purchase Planning Handbook* (PPH). Aircraft manufacturers attempt to optimize performance in all areas, but tradeoffs are a reality of aircraft design. Speed vs. range, range vs. payload, cruise performance vs. airport performance are among those. For years, we've qualified the PPH numbers and those in our aircraft performance charts by noting actual performance will be affected by the weight of options, air traffic delays, weather, non-standard temperatures and other variables. The 1,900-nm max range of the CJ4 and 2,080-nm max range of the new Learjet 75 Liberty are attainable only under optimal conditions. **Fred George**

Be More Confrontational?

My family has been involved in civil aviation ever since my late father soloed a J-3 Cub in 1944 during time off from his USAAF B-17 mechanic's enlistment at Tampa, Florida. Two of my brothers flew Lears for Clay Lacy out of Van Nuys, California (KVNY), and I've got a ton of Cessna P210 and Beech S35 time during a career in real estate and health care. I still fly a simple "Spam-can" VFR.

My son is a national talent hardware engineer for a Silicon Valley consumer electronics firm known to everyone, and if his circuits worked as well as climate scientists' predictions, he would be without a job.

With respect to "**No Alternative**" (**July 2019**), I think the civil aviation business should be more confrontational, not collaborationist with respect to the politics of climate change. The Hollywood and sports stars and big-shot liberal politicians all love their executive jets — no way they're gonna fly with the plebeians. I think the industry should put together a "no fly" list of bad actors and hypocrites and see how they like surface transport.

Best wishes for safe flying.

Stephen Power
Nut Tree Airport (KVCB)
Vacaville, California



Boeing's Blues

Your reporting on the problems with the Boeing 727 MAX ("**Lessons From the MCAS Accidents**," **June 2019, page 46**) was better than anyone else had done in any media. It is a very complex issue to fully explain.

Reading the first articles in *The New York Times* and other publications I thought there had to be more to it than what they were reporting. It wasn't just dumb pilots who didn't know how to turn off the bubble machine (even though they didn't). There had to be an unknown factor lurking that hadn't been explored in those first articles. Fred George's writing was so good, so thorough, and so clearly presented that I had to write in response. Excellent job.

My own opinion (borne as always from ignorance and prejudice) was that Boeing's first mistake was trying to put a Band-Aid on an old design rather than greenlighting its new airplane for that market. Then they tried to rush it all through and neglected to let the pilots in on it. That makes me mad, because Boeing is such a great company and has built wonderful, safe, economical airplanes for many decades. To see the company mess up so blatantly is an outrage. It was bad management, and that almost always starts at the top. Makes me think that had Alan Mulally been in charge this wouldn't have happened.

Russ Munson
New York, New York

Editor's Response: These crashes are canaries in the coal mine, symptoms of much greater air safety risks. **Fred George**

If you would like to submit a comment on an article in *BCA*, or voice your opinion on an aviation related topic, send an email to jessica.salerno@informa.com or william.garvey@informa.com



Analyze the business aviation market to capture your next deal.

- Market and competitive insights
- Fleet data services: historical and current fleet ownership and status; forecast and valuations
- Research and analysis offerings

Take your business to the next level.

Visit pgs.aviationweek.com/GlobalBusinessAviationSolutions

or call Anne McMahon at + 1 646 291 6353 or
Thom Clayton +44 (0) 20 7017 6106

AVIATION WEEK
NETWORK



GE Honda Aero Engines

FL450 ADVANCED SILENT TOUGH EFFICIENT RELIABLE

Accelerating Innovation: The All New HF120

Two names synonymous with invention have joined forces to create unprecedented performance—a product igniting change in the industry—the all-new 2,000-pound thrust class turbofan power plant. Built to last, the HF120 delivers advanced technology designed for speed, endurance, and the smoothest ride.

FL450: The fastest engine in its class, the HF120 enables effortless climb to FL450 and beyond. Its high fan and core pressure ratio provides increased aircraft speed and reduced climb time to higher cruising altitudes. With a low thrust lapse rate, the engine allows for initial climb in excess of 4,000 feet per minute and reduces time to climb by 40%.

ADVANCED: The engine represents decades of research and development. A wide-chord, swept titanium blisk fan with composite fan outer guide vanes and the use of innovative turbine blade and combustor materials are just some of the unique features the HF120 brings to the light jet market.

SILENT (Inside & Outside): Smart placement of the rotor dynamic resonant frequencies outside of the engine taxi and flight settings minimizes unwanted cabin noise. Tight tolerance controls and exceptional build quality deliver low fan and core vibration levels. Low levels of vibration transmission to the fuselage result in a quiet cabin and the smoothest flying ride in its class.

TOUGH: Setting new standards for durability and efficiency, superalloys used in the hot section permit a higher operating temperature with extended parts life. All HF120s are monitored closely via proven large aircraft engine proactive diagnostic systems to minimize downtime and enable longer uninterrupted service.

EFFICIENT: Using innovative aerodynamic designs, the HF120 delivers greater cycle efficiency while optimizing operability. Unique airblast fuel nozzles provide better fuel atomization yielding superior fuel-to-air combustion to minimize fuel burn. Laser drilled combustor liner holes ensure minimum pressure drop across the combustor, enabling optimum transfer of compressor energy

to the turbine side. This unique design offers outstanding overall environmental benefits, including low NOx, CO, and HC emissions.

RELIABLE: All of these amazing features combine to create an engine that redefines dependability. Extensive testing in excess of 23,000 cycles and simulated 5,000 flight cycles run on a single engine reveal proven reliability and readiness for longer uninterrupted operation.

The HF120 enjoys enviable operational success. It's an incredible machine built to set a new standard for the light jet market—ready for applications beyond its current aircraft installation. ■

INTELLIGENCE

EDITED BY **WILLIAM GARVEY,**
JESSICA A. SALERNO AND
MOLLY MCMILLIN
william.garvey@informa.com
jessica.salerno@informa.com
molly.mcmillin@informa.com

NEWS / ANALYSIS / TRENDS / ISSUES

► **ON AUG. 8, GULFSTREAM ANNOUNCED MAKING ITS FIRST G600** delivery to a customer, one month after the aircraft earned its FAA type and production certificates. The handover to a U.S. operator took place at Gulfstream headquarters in Savannah, Georgia. “We always strive to exceed our customers’ expectations, and our first G600 delivery is a prime example of that,” said Gulfstream President Mark Burns. “The effort put forth by our team enabled this award-winning, technologically advanced aircraft to move from certified to delivered in an extremely short period of time. We are very proud of everyone who had a part in making this happen and keeping our promise to customers, as is a Gulfstream tradition, of a 2019 entry into service. As for what’s next, Burns said, “We have only just begun.” The G600 received both FAA type and production certificates and entered service after a design and test program that included flying nearly 100,000 hr. in the company’s labs and more than 3,200 hr. of flying in the air. The all-new model can carry passengers nonstop from Paris to Los Angeles or Hong Kong at an average speed of Mach 0.90 and 6,500 nm (12,038 km) at its long-range cruise speed of Mach 0.85. Its maximum operating speed is Mach 0.925. The newest Gulfstream features a flight deck with active control sidesticks and 10 touchscreens. The model’s advanced technology has earned Gulfstream several citations, including *Aviation Week & Space Technology’s* 2017 Technology Laureate Award.



► **ON AUG. 2, ICON AIRCRAFT ANNOUNCED IT WOULD CUT** hundreds of jobs and the production rate of its A5 model because of reduced demand and the loss of funding from its Chinese investors — the latter a byproduct of the U.S.-China trade turmoil, according to Thomas Wieners, Icon president and COO. In addition, Icon has suffered from lower demand after increasing the retail price of its two-seat amphibious light sport aircraft several times to its current \$389,000 per unit. “After producing more than 100 aircraft, we now have a very good understanding of costs,” Wieners said. **“And while the Icon A5 is truly an exceptional plane, the necessary higher price lowers demand considerably.”** The move will lower costs and “right size” the business, it said. The cuts effective immediately, reduce employment at its assembly site in Vacaville, California, and its composite production facility in Tijuana, Mexico, from about 650 to 400. At the beginning of 2019, Icon’s key Chinese investors had been “confident and bullish,” on investing, Wieners said, with plans to complete a round of funding in March and again in September or October. Those targets will not be met. Without the funding, Icon operated on loans for the first half of 2019, Wieners said. However, he added that the company recently received a new round of funding from other investors, which will keep core functions operating. As a result, Icon is cutting production from five A5 aircraft per month to an undisclosed number. It delivered five aircraft the same week it announced the job cuts and restructuring. It recently announced delivery of its 100th aircraft. Icon has also suffered from two high-profile accidents. In 2017, Jon Karkow, its lead engineer and test pilot, and another employee were killed after Karkow flew an A5 into a canyon and crashed during a turn. That same year, retired Major League Baseball pitcher Roy Halladay was killed when his A5 crashed into the Gulf of Mexico. The aircraft was not blamed in either accident.



Jet-A and Avgas Per-Gallon Fuel Prices August 2019

Jet-A			
Region	High	Low	Average
Eastern	\$8.77	\$4.50	\$6.23
New England	\$7.78	\$3.87	\$5.21
Great Lakes	\$8.15	\$3.34	\$5.53
Central	\$7.53	\$3.37	\$4.95
Southern	\$8.24	\$4.35	\$6.05
Southwest	\$6.90	\$3.36	\$5.31
NW Mountain	\$7.92	\$3.43	\$5.33
Western Pacific	\$8.69	\$3.90	\$6.04
Nationwide	\$8.00	\$3.77	\$5.58

Avgas			
Region	High	Low	Average
Eastern	\$8.89	\$4.90	\$6.56
New England	\$7.45	\$5.00	\$5.94
Great Lakes	\$8.59	\$4.59	\$6.07
Central	\$7.59	\$4.51	\$5.51
Southern	\$9.14	\$4.30	\$6.29
Southwest	\$7.19	\$4.23	\$5.65
NW Mountain	\$8.46	\$4.65	\$5.79
Western Pacific	\$8.52	\$4.99	\$6.33
Nationwide	\$8.23	\$4.65	\$6.02

The tables above show results of a fuel price survey of U.S. fuel suppliers performed in August 2019. This survey was conducted by Aviation Research Group/U.S. and reflects prices reported from over 200 FBOs located within the 48 contiguous United States. Prices are full retail and include all taxes and fees.

For additional information, contact Aviation Research/U.S. Inc. at (513) 852-5110 or on the internet at www.aviationresearch.com

✦ *For the latest news and operational information, go to bcadigital.com*

Honda Aircraft Expands Greensboro Facility



Honda Aircraft is further expanding at its 133-acre site at Piedmont Triad International Airport (KGSO) in Greensboro, North Carolina, by adding a new wing production facility. The company held a ground-breaking ceremony for the \$15.5 million, 83,000-sq.-ft. expansion on July 30. The facility will include additional storage for service parts for its global fleet of very light jets. Construction is expected to be completed by next July.

Blackhawk Receives STC for King Air 300 Engine Upgrade



Blackhawk Aerospace, the Waco, Texas, conversion outfit, has earned a Supplemental Type Certificate (STC) from the FAA that it says will transform the Beechcraft King Air 300 into “the fastest King Air in the world.” This upgrade includes installation of factory-new Pratt & Whitney Canada PT6A-67As to replace the stock PT6A-60As on 12,500-lb. and 14,000-lb. gross weight models of the King Air 300, along with composite, five-blade and swept Hartzell propellers.

▶ **THE FAA HAS GRANTED TEXTRON AVIATION PERMANENT RELIEF** from fuel-tank requirements that have delayed certification of the Cessna Citation Longitude, a move that should clear the way for deliveries to begin in the third quarter. When launched in 2012, Cessna’s largest business jet was expected to enter service in 2017. But late in development it was realized the wing-tank design did not comply with the fuel flammability exposure requirements of FAR Part 25 certification. In August 2018, the FAA granted Textron a time-limited exemption to address the tank design’s non-compliance. The company redesigned the fuel system to add a dedicated pump to circulate the heated motive-flow fuel to the outboard wing to be cooled before flowing inboard to the collector tank. This change allowed the Longitude to comply with the average fuel-tank flammability requirement, but the FAA categorized the recirculation system as a flammability reduction means (FRM), which triggered more requirements. The problem with the recirculation solution is that its effectiveness depends on airflow over the wing skins to cool the fuel. However, on the ground and during take-off and climb, hot fuel is flowing into the tanks and there is negligible cooling. This prevents the design meeting



the additional FRM demands. In its exemption decision, the FAA says Textron provided evidence that its final design, while not capable of complying directly with the requirement, shows equivalent or reduced warm-day tank flammability when compared with a conventional unheated aluminum wing tank under similar conditions. **“The FAA agrees with Textron’s assessment that additional modifications to directly comply with [the regulation] are impractical given the late stage of the airplane development program and likely costs,”** says the decision document. “The design modification that Textron has incorporated into the Model 700 [Longitude], in order to cool the fuel tank and reduce fuel heating, improves the overall tank flammability,” the decision continues. “Due to the timing in the airplane development program, with certification imminent, it is impractical to incorporate a different type of FRM [that would directly comply with the regulation].” “This exemption is very narrowly focused on specific sections of an appendix to the fuel-tank flammability regulation,” says Textron. “This is the permanent means of full compliance with the regulation. All deliveries will have a compliant system incorporated.”

▶ **A PILOT SHORTAGE IS A PROBLEM FOR OPERATORS, BUT IT’S PROVING** to be a bankable opportunity for those building training aircraft and related equipment. For example, Piper Aircraft President and CEO Simon Caldecott recently noted that market reaction to his company’s new lower-cost Pilot 100 and 100i trainers has far exceeded expectations, with purchase commitments for more than 100 Pilot aircraft from flight schools around the U.S. Sales announcements for training aircraft at EAA AirVenture in Oshkosh, Wisconsin in July included 50 Pipistrel Alpha Trainers and up to 160 Cessna Skyhawks. In addition, Continental Aerospace unveiled a drop-in replacement engine for some Lycoming-powered Skyhawks, and BendixKing announced a new cockpit upgrade for single-engine Cessnas. High pilot demand is also an opportunity for Cirrus Aircraft, the company’s new CEO Zean Nielsen said. “There’s a lot of demand coming, and they’re looking for technologically advanced safe aircraft, and they’ve been coming to Cirrus Aircraft, which is pretty exciting,” Cirrus senior vice president of sales and marketing Ben Kowalski said. Dubai’s Emirates Airline, for example, selected Cirrus SR22 aircraft for its Emirates Flight Training Academy’s ab initio program. And Lufthansa Aviation Training, the flight training program of Lufthansa Airlines, selected the Cirrus SR20.

► **AMAZON WANTS TO OPERATE ITS PRIME AIR DRONE DELIVERY** service as an air carrier under FAR Part 135. In a notice published in the *Federal Register* on Aug. 8, the online retail giant sought relief from the requirement that a civil aircraft used for commerce must have an airworthiness certificate along with some other provisions. The MK27 drone Amazon plans to use in the service is a battery-powered, shrouded, six-rotor un-



manned aircraft system (UAS) with a maximum gross takeoff weight of 88 lb. and capable of vertical takeoffs and landings and wing-borne flight. It is designed to carry an internal payload of 5 lb. and has a roundtrip range of 15 nm. The would-be operator said it plans to begin package delivery in thinly populated areas that have been “thoroughly vetted” for proximate airborne traffic, obstructions, communications

coverage and other factors, subject to obtaining FAA authorization. Though Amazon was one of the first large companies to signal its interest in drone package delivery – announced by CEO Jeff Bezos in December 2013 – it has closely guarded information about its plans. **The company unveiled the MK27 design in June, but not its specifications.** Amazon’s petition letter, signed by Sean Cassidy, the company’s director of safety and regulation, says the company formally entered an aircraft type certificate program “status” for the MK27 in 2017 and has been engaged with the FAA on a weekly basis since then. But rival Alphabet Wing was the first drone delivery system developer to obtain a Part 135 certificate from the FAA in April. The FAA was accepting comments on Amazon’s petition until Aug. 28.

► **ON AUG. 4, FRENCHMAN FRANKY ZAPATA RODE HIS FLYBOARD AIR**, a jet-powered platform aircraft he developed, across the English Channel from Sangatte, near Calais, France, to St. Margaret’s Bay near Dover in some 22 min. The event came 110 years after the



first successful airplane crossing by Louis Bleriot. The flight was Zapata’s second attempt at crossing the Channel in a week. In his July 25 try he was forced to ditch during an attempt to land on a boat to refuel halfway across. The same refueling technique was used on the successful flight but with a larger boat and a more spacious landing platform. Zapata’s feet were strapped to the Flyboard Air, a platform powered by five small jet engines and fueled from a tank fitted in his backpack. Steering the aircraft was achieved by leaning in the direction of travel; throttle control was provided by Zapata’s balance and a control stick in his right hand. “It’s crazy,” the pilot said after the flight. “Whether

this is an historic event or not, I’m not the one to decide that. Time will tell.” Zapata said flying the aircraft was challenging due to air resistance during his 160-170 km/hr. crossing speed and because he pushed the technology to fly fast and for a long period. The system was born out of Zapata’s work on hydroflight, using water jets to lift people into the air. The Flyboard Air platform has attracted the interest of the French military, which has provided a €1.3 million (\$1.4 million) grant to Zapata Racing, Zapata’s development company. Zapata also demonstrated the aircraft in Paris on Bastille Day, July 14, in front of French politicians, including President Emmanuel Macron.



Dickson Sworn in as 18th FAA Administrator



Stephen M. Dickson was sworn in as FAA administrator on Aug. 12. Capt. Dickson retired from Delta Air Lines last fall after 27 years at the company where he began his career as a pilot and rose to become senior vice president for flight operations. The FAA was without a confirmed administrator since early 2018 when Michael Huerta’s term ended. Since then the agency was run by Acting Administrator Daniel Elwell.

Wutong Aviation Signs LOI for 100 Guanyu GA20 Aircraft



According to a China News account, the Guanyu GA20 has garnered letters of intent for 100 units. A four-seater powered by a Lycoming O-320 engine and featuring Garmin avionics, the GA20 was developed by Shanghai-based Guanyu General Aviation. Wutong Aviation Sci-Tech Co., a private aircraft service company in China, signed the underwriting agreement with Guanyu for the 100 aircraft. Guanyu began developing the GA20 in 2014 for use in aviation training, private aviation and tourism. It expects Chinese certification in about 2020.

Latin America Fleet to Grow by 790 Units by 2028



Over the next 10 years, customers in Latin America are expected to take delivery of nearly 790 new business aircraft, with turboprops dominating the market, according to the Aviation Week 2019 Business Aviation Fleet & MRO Forecast. However, in that same decade, Aviation Week projects the Latin American fleet to shrink from the current 4,340 aircraft to 3,585 in 2028 at which time the King Air 90 and King Air 200/250 are expected to be the top-delivered products.

Sheltair Breaks Ground for Rocky Mountain Airport FBO



Sheltair Aviation broke ground for its full-service FBO at Rocky Mountain Metropolitan Airport (KBJC) on Aug. 15. The 21-acre state-of-the-art, \$20 million complex will include a new terminal, hangar and build-to-suit office space opportunities. When completed in 2020, the new facility will mark Sheltair's first FBO presence west of the Mississippi River. The construction milestone reflects Phase One of Sheltair's development plans at KBJC with a new 10,000-sq.-ft. FBO facility featuring 10 acres of aircraft parking apron and parking for up to 120 vehicles.

▶ **CAPE AIR, A REGIONAL CARRIER BASED IN CAPE COD, Massachusetts,** recently took delivery of its first two Tecnam P2012 Travellers following inspection of the nine-passenger aircraft at the manufacturer's production facility in Capua, Italy. Powered by two 375-hp Lycoming piston engines, the P2012 received FAA certification in July, clearing the way for the aircraft to be ferried to Cape Air's base in Hyannis. Initially the aircraft were scheduled for pilot and maintenance training. The carrier plans to introduce the P2012 into service in November. "[That's] a very ambitious time frame, but some of our communities are dying to get the airplane . . . so they are they're asking us to commit," said Cape Air CEO Dan Wolf. "By the end of this year, certainly, we think that's achievable." The Traveller is planned to replace Cape Air's fleet of 85 Cessna 402s. The airline signed a letter of intent for 100 aircraft in 2015 and the first 20 on firm order are scheduled for delivery by the end of



2020. For every three P2012s it accepts, the airline plans to retire one or two of the twin Cessnas. "[That] allows for some modest growth but also allows for us to retire the higher-time 402s," Wolf said. **Compared with the Cessna 402, the P2012 has one more passenger seat — a 13% increase in capacity. "It will**

be quiet and more comfortable," said Wolf. "The cabin is roomier. The rear seats in the 402 are headroom-limited. This is a full cabin all the way back. And it does have air conditioning. This is a function of climate change: The areas we are flying in are much hotter than they used to be." Cape Air also expects a big reduction in maintenance costs. The aging 402s are requiring 2.5-3 hr. of maintenance for every flight hour. The P2012 is calculated to require 0.5 hr. of maintenance per flight hour. "So," Wolf observed, "we are going to be saving 2 to 2.5 hr. in technician labor hours per flight hour." Furthermore, he said, the Traveller's smaller footprint should make it easier for Cape Air to add bases to expand its network.

▶ **TAMARACK AEROSPACE GROUP ANNOUNCED AUG. 9 IT HAD** received final U.S. Bankruptcy Court authorization to accept \$1.95 million in new funding from a consortium of customers, vendors and company stakeholders. Company President Jacob Klinginsmith said the investors "understand our industry and believe in the long-term value of our innovative active winglet product. This financing from friendly investors is now the only debt secured by our intellectual property and is an important step in our reorganization." The debtor-in-possession financing will help sustain the Idaho company following U.S. and European regulatory action that grounded Cessna CitationJets equipped with Tamarack's active winglets and forced the company to seek Chapter 11 bankruptcy protection in June. The FAA and the European Aviation Safety Agency subsequently lifted their restrictions on CitationJets that were upgraded. The restrictions affected 91 aircraft in the U.S. and Europe. All but two had been upgraded by Tamarack by the time the restrictions were lifted. "We're excited to be back on track with our sales and installation process," Klinginsmith said on Aug. 9. **"We have several installations scheduled or in process now, and we're seeing strong interest. It's going to be a good second half of the year."** The Tamarack winglet system comprises a wingtip extension, a highly tuned winglet, wing loading sensors and a moveable load alleviation surface. According to the company, the fully autonomous, fail-passive, load alleviation system counteracts gust- or maneuver-induced wing loading.



CORPORATE ANGEL NETWORK



Fund an Angel Cocktail Reception

Wednesday, October 23 | 6-8 P.M. | Wynn Las Vegas

The 10th Annual Fund an Angel Cocktail Reception, held on the second day of the NBAA Business Aviation Convention & Exhibition (NBAA-BACE), is an invaluable networking event for business aviation leaders and influencers. The reception will feature an auction to benefit Corporate Angel Network (CAN) who organizes critical flights for cancer patients to treatment centers throughout the country.



"Corporate Angel Network has helped to open up trials and treatment for Ava that we otherwise could not afford. They help to ensure she gets the medical care that she needs."

- Ava's Parents

Learn More and Reserve Tickets: fundanangel.org

A SPECIAL THANKS TO OUR CURRENT SPONSORS

Presenting Sponsor  NBAA

PLATINUM



GOLD



TEXTRON AVIATION

SILVER



BRONZE



Sky Trek Aviation Becomes Modesto Jet Center



Sky Trek Aviation at Modesto City-County Airport, based in California, has new ownership and a new name. Its new name, Modesto Jet Center, became effective Aug. 1. Matt Bosco and Dan Kimmel, longtime customers of Sky Trek Aviation, acquired the FBO from Jim Van Heukelem, Penny Weber and John Rogers, who operated the company for more than 30 years.

Signature Flight Support to Acquire IAM Jet Center



Signature Flight Support has agreed to purchase IAM Jet Center and its affiliated companies. The addition of five FBO locations complements Signature's existing FBOs in the Caribbean. The acquisition includes IAM Jet Center's locations at Barbados' Grantley Adams International Airport, Maurice Bishop International Airport in Grenada, Terrance B. Lettsome International Airport in Tortola and Sangster International Airport in Montego Bay, Jamaica. Another FBO is under construction at Hewanorra International Airport in St. Lucia.

► **XJET'S FBO AT LONDON-STANSTED AIRPORT IS SETTING** new standards in luxury with its "tailored branding" service introduced in June. The FBO occupies 93,863 sq. ft. within the spacious 250,000-sq.-ft. Diamond Hangar Aviation Hub. It was launched in 2014 and completes more than 1,300 aircraft movements annually. At one point it recorded more than 150 passengers passing as part of a single movement. Most recently a 17,000-sq.-ft. major upgrade resulted in the creation of two majlis rooms — one for men and another for women — each with a private lavatory. According to FBO Deputy Manager Carly Swetman, "They are designed to ensure maximum privacy as well as ultimate comfort."



Privacy also extends to a private security screening area. The refurbishment also included a large conference room that can seat 12 people comfortably, as well as a dedicated espresso and cocktail bar. And inside the lounges, XJet showcases a changing collection of art and sculpture by talented and emerg-

ing artists from all over the world. Crew services include a luxurious lavatory with shower, an on-site gym, complimentary Wi-Fi and satellite television, preferential crew hotel rates and weather briefings. A crew rest area includes four individual sleeper pods that are cleaned and changed out after every use. XJet also has introduced an "immersive experience" that allows

tailored branding to a client's specific requirements. This system allows the FBO to carry out direct electronic online filing of General Aviation Reports (GARs), load sheets, and personalized boarding passes and luggage tags. XJet also can update charter brokers of their flight's status via automated text messages, including "Passengers Have Been Screened," "Passengers Boarded," "Doors Closed" and "Aircraft Airborne," thereby reducing the need for telephone calls and emails. In a world where space is often at a premium, XJet works closely with Diamond Hangar to provide hangar and ramp space for anything from helicopters to a BBJ 747. The hangar also provides 150 parking slots for clients arriving by car. Security at the facility is enhanced by the strategic placement of an integrated system of CCTV cameras. Taking the concept of service still further, XJet builds client profiles that allow them to create a more personalized service. "It's all about going beyond expectations," said Flight Support Concierge Lauren Clark. — Kirby Harrison



► **BARRINGTON IRVING, WHO IN 2007 BECAME THE YOUNGEST PILOT** to fly solo around the world in a single-engine airplane and continues to inspire young people to pursue aviation careers, has been named by the NBAA as the recipient of its **2019 American Spirit Award. It will be presented at the association's Business Aviation Convention & Exhibition in October in Las Vegas.** A native of Kingston, Jamaica, Irving grew up in inner-city Miami, where upon graduating from high school, he embraced aviation under the guidance of a Jamaican airline pilot. Those experiences set Irving on a course that culminated in his 97-day solo flight to demonstrate to young people worldwide that they could also achieve their dreams. He then founded Experience Aviation, based at Opa-Locka Executive Airport (KOPF), and established the Experience Aviation Learning Center dedicated to empowering middle and high school students in the Miami area to seek careers in science, technology, engineering and math, including within aviation and aerospace. And he continues to encourage students from all walks of life with the Flying Classroom, combining air, land and sea expeditions with a digital curriculum to engage millions of children throughout the world.

Bringing Cancer Patients Closer to Their Cure

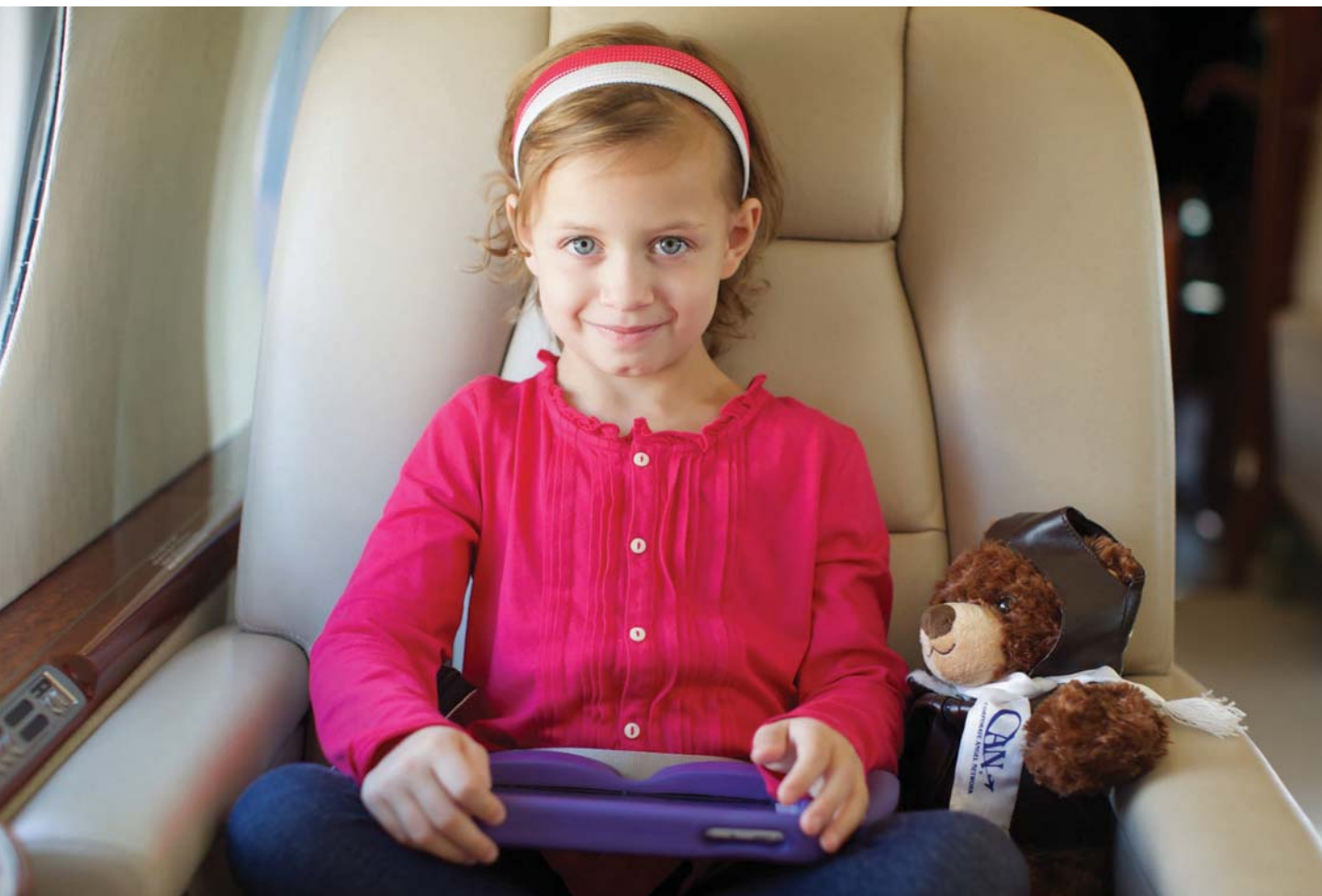

Cancer Patients Fly Free in Empty Seats on Business Jets

- Corporate Angel Network arranges free flights to treatment for cancer patients by using empty seats on business jets.
- Since 1981, Corporate Angel Network, a not-for-profit organization, has worked with more than 500 corporations including half the *Fortune* 100, to fly close to 60,000 cancer patients to specialized treatment and currently transports 250 patients each month.
- The process is simple. Call or visit our website for more information.

Close to 60,000 flights and counting!

Corporate Angel Network

(866) 328-1313 WWW.CORPANGELNETWORK.ORG
TWITTER: @CORPANGELNET INSTAGRAM: @CORPORATEANGELNETWORK



John McKenna

Chairman, Recreational Aviation Foundation (<https://theraf.org>), Bozeman, Montana

A Montana native, McKenna just naturally gravitated to airplanes — something his non-pilot father encouraged along with playing golf. Dad's thinking: Business deals are sealed on fairways, and if you're going to do business in the wide-open West, airplanes expedite the necessary travel. This latter fact was demonstrated by a neighbor, a contractor, who would fly young McKenna in his Bonanza on weekends to check on various building sites. McKenna earned his private pilot's ticket at 17 and since then has logged some 7,000 hr., almost all in light aircraft — he's operated a Cessna 185 since 1988 — and a whole lot of those in the mountains and forests of the American West. With a master's degree in financial services from the University of Pennsylvania, McKenna has spent his entire 45-year sales career with New York Life, the same company with whom his father was long affiliated, and now two of his daughters have joined as well — a family run of 125 years, and counting.



TAP HERE in the digital edition of **BCA** to hear more from this interview or go to aviationweek.com/fastfive

Questions for John McKenna

1 How did the RAF come to be, and why?

McKenna: One summer weekend in 2003, six of us flew into Schafer Meadow, a public-use U.S. Forest Service strip in the backwoods of northwest Montana, for some fishing, hiking and storytelling around the campfire. We all acknowledged that we were privileged to fly into such places and that they had to be preserved for those who follow. And as the night went on and as the Scotch flowed, we agreed that it was us who should take up the cause. Somewhat to our surprise, we felt the same over cowboy coffee the next morning and got started.

2 Are there many such strips?

McKenna: The Forest Service together with the Bureau of Land Management and National Park Service operate some 750 to 800 remote airstrips on mostly western federal land. The large land holdings in the eastern part of the country are mostly privately owned and together have probably the same number of remote airstrips. We've successfully lobbied a number of state legislatures to protect private owners from any liability should a mishap occur involving a visiting aircraft. Of course, once the trial lawyers got wind of that, they started pushing back. But we're making good progress.

3 How do you measure that?

McKenna: We've helped to restore, secure or develop some 50 backwoods airstrips so far, with more on the way. One highlight was the day Ben and Butchie Ryan — he was a P-38 pilot and she an Army nurse in World War II — gifted the RAF their wonderful private grass strip bordering Glacier National Park. Others say they plan to do the same. Our success also shows in our membership of volunteers, which has grown to 10,000 from all 50 states and 15 foreign countries.

4 Those members include major figures in business aviation. How important is that segment to the RAF?

McKenna: There's a great deal of crossover. Business aviation gravitates to the RAF. Many of the individuals are like me, operating light twins and singles in growing their businesses. My 185 allowed me to engage with people in a large geographic region and to expand, visiting people on their farms and ranches, even landing — with permission — on secondary roads and taxiing into parking lots. Without that airplane, I'd be just another local life insurance guy. But typically, if you go into a small company hangar housing its Cessna 421, TBM or PC-12, you'll find a Husky or Super Cub behind it. You know what they do on the weekend.

5 How is the organization financed?

McKenna: We survive strictly on donations, which thanks to our 501 (c) 3 IRS status, are all deductible. Our expenses are low; we've got just one and a half staffers to answer the phones and open mail. The majority of our revenue is used to further our mission by opening, upgrading or maintaining airfields; promoting the organization at different venues like Oshkosh; and participating in forest planning sessions. One really satisfying investment was our infamous "poop study." Opponents kept insisting that airplanes spooked the wildlife, but their evidence was all anecdotal. So, we backed a graduate study that involved bagging fresh scat found shortly after landing, freezing it and then analyzing the stuff in a lab. The key measure was the critical steroid level — if it was high, the animal was alarmed, if low, the encounter was no big deal. Well, the levels were consistently low. Now, we won't take any more scat from anyone. **BCA**



OPEN UP THE BOARDROOM

Work efficiently without limits.

Connect in real time with the secure, high-performance, low-latency network.

The Best User Experience • smartskynetworks.com/ATG • 800.660.9982





Fixated on Landing

The dangers of ignoring SOPs

BY RICHARD N. AARONS bcasafety@gmail.com

Air Niugini Flight 73, a Boeing 737-8BK with 12 crew and 36 passengers, descended into Chuuk Lagoon, skipped across the water like a skimmed stone, then sank in shallow water some 1,500 ft. short of Chuuk International Airport's Runway 4 threshold. The crew was executing an RNAV (GPS) approach to the Western Pacific island airport, and descended below the MDA in heavy rain, while ignoring 17 EGPWS alerts — specifically eight “SINK RATE” and nine “GLIDESLOPE” calls.

**Pohnpei approach flight path (top);
Depiction of aircraft in relation to
Chuuk International Airport
Runway 04 threshold (bottom).**

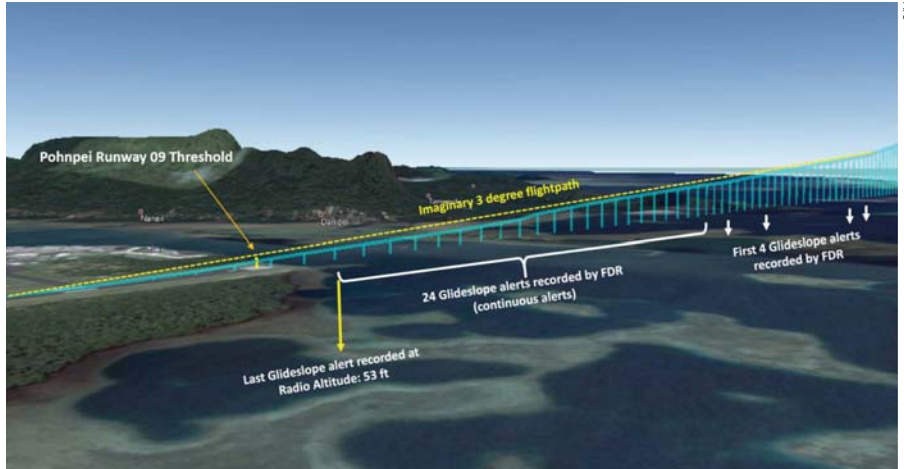

Six passengers suffered serious injuries and one was trapped in the wreckage and died. The crewmembers and surviving passengers exited the aircraft through over-wing exits and doors and were promptly rescued and brought to shore by Chuuk state government boats and other watercraft operated by the Red Cross, Transco, the U.S. Navy and private citizens who were first on scene.

The accident occurred on Sept. 28, 2018, at 09:24 local time (23:24 UTC). The aircraft — P2-PXE (PXE) — was conducting a scheduled passenger flight from Pohnpei to Chuuk in the Federated States of Micronesia (FSM).

So what happened? How did a highly experienced crew fly their perfectly performing airplane into the lagoon? The answer is found in what follows — mostly from the investigation done by the Papua New Guinea Accident Investigation Commission (AIC).

The Flight

The pilot in command (PIC) and copilot began their day in Pohnpei at about 07:05 local (21:05 UTC) for a flight to Port Moresby, Papua New Guinea, via Chuuk. The scheduled departure time was 07:50 local (21:50 UTC). The aircraft departed from Pohnpei at 8:22



local (22:22 UTC), with the PIC at the controls (PF) for the sector to Chuuk. The copilot was the support/monitoring pilot (PM).

A flight mechanic rode the jump seat. Happily, at least for the investigators, he used a smartphone to record the Chuuk approach from about 3,000 ft. for recreation purposes. The video abruptly ended upon impact, but the phone survived and provided clear imagery of the cockpit environment and instruments.

The captain was 52 years old and a native of Papua New Guinea. He held a PNG ATP and was typed in the Boeing 737 series. He had accumulated 19,780 hr., some 4,900 as PIC and 2,300 in the 737. He had flown 44 hr. in the previous 30 days and 18 in the last week.

The Australian national first officer (F/O) held a PNG ATP and was typed on the 737 series. He had accumulated 4,618 hr., 1,800 hr. command time and 368 hr. as a B737 copilot. He had flown

FlightSafety is Here For YOU



Your Success

Relax. Our instructors work to ensure YOU have an exceptional training experience with a positive outcome.

Your Proficiency

Be the very best. We are committed to helping YOU achieve and maintain the highest level of skills and safety.

Your Satisfaction

Count on us. We all have the same goal: providing YOU with the highest-quality training and outstanding service.



Train with FlightSafety and benefit from our unequalled experience, team of master instructors and safety-focused programs using state-of-the-art simulation technology. Trust that we'll always go above and beyond for you and your flight department and deliver the value you deserve and expect. It's all about you.

FlightSafety
international

flightsafety.com • 314.785.7815

Cause & Circumstance

43 hr. in the previous 30 days and 9 hr. in the last week.

The climb and en route segments were conducted without incident — entirely routine. Prior to top of descent (TOD), the crew briefly discussed settings for the brakes and flaps. The copilot asked the PIC if they should use flaps 30 and the PIC replied “Yeah, flaps 30 would do; 141 plus 5 ah. . .” The discussion continued around whether to use flaps 30 or 40.

The copilot entered the relevant data into a Boeing Onboard Performance Tool (OPT) program for the electronic flight bag (EFB) he was carrying and determined the use of flaps 40 would reduce the landing distance required by about 150 meters. He informed the PIC and the PIC agreed to select flaps 40 for the final approach segment.

The pilots then briefly discussed the approach and missed-approach procedures, the latter should a miss become necessary if they found themselves in IMC at the MAP — HAMAX waypoint. (See the approach plate.) The approach briefing was not the detailed discussion required by their airline SOPs. Indeed, the missed approach procedure was just a cursory mention of DAMAY waypoint and did not cover the procedure, nor the flight path to be followed. The landing checklist was given a similar haphazard briefing.

At 08:54 local (22:54:36 UTC), regional ATC (named San Francisco Radio) contacted the crew with the following decent clearance:

“ATC clearance. Niugini 73, descend to reach FL 340 by time 23:05Z, requirement to reach FL 340 by time 23:05Z, and report level, FL 340. Cruise, FL 340, to Chuuk airport, report arrival. Report leaving FL 280, flight level 180 and flight level 080, time, time check, 254 and a quarter.”

At TOD, the captain stated to the copilot that they were already high and needed to initiate their descent immediately. The crew descended out of FL 400 at 22:56:18, at a rate of 944 fpm. At FL 340, the copilot reported to ATC that they were maintaining FL 340. Both pilots talked for 2 min., trying to recall and clarify the instructions that they had been given.

At 23:05:14, while maintaining FL 340, the PIC stated to the copilot that they were high on profile and needed to descend to get back on the required descent profile.

At 23:08:16, the PIC said, “Alright, we are catching back on profile, so just keep the speed up.”

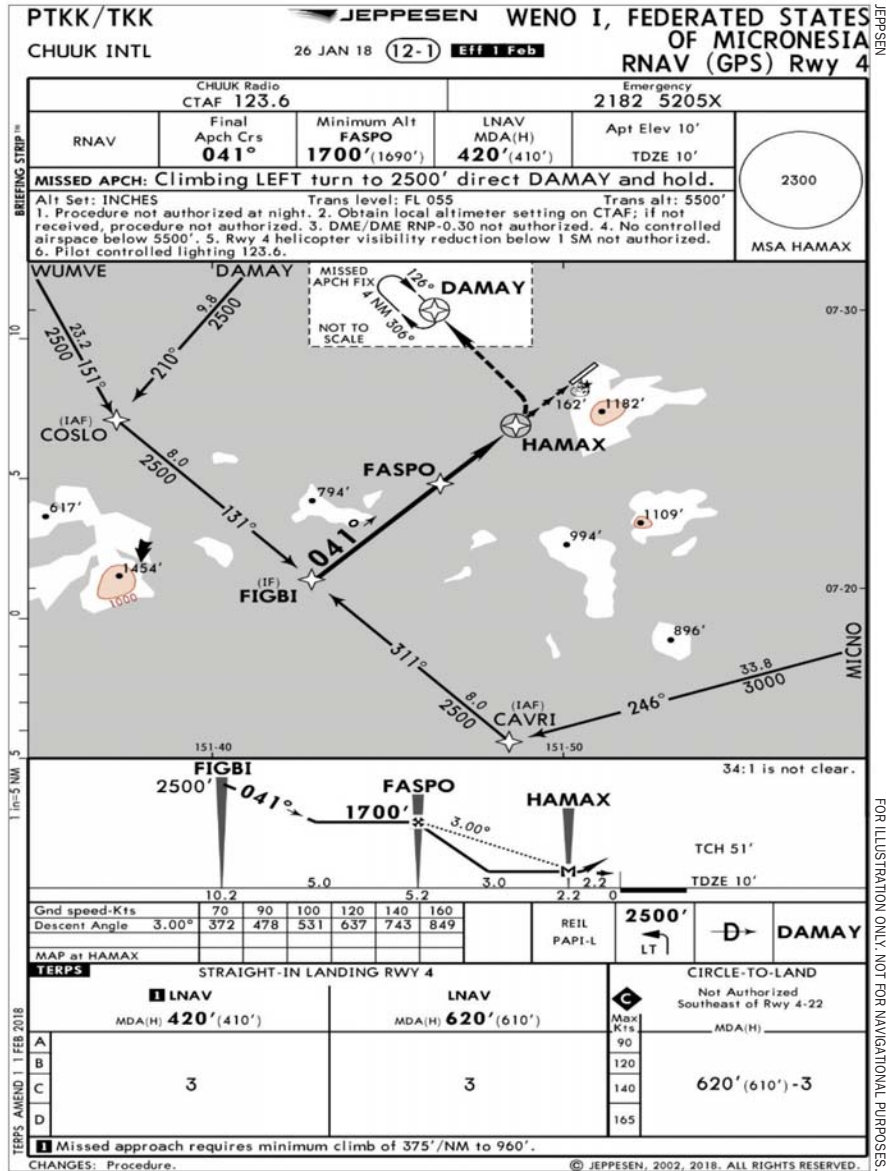

The copilot contacted Chuuk radio at 23:08:54 and requested a weather update. Chuuk acknowledged and asked the crew to standby. The PIC, realizing that they were still high on profile, instructed the copilot to go on VNAV.

At 23:11:00, Chuuk radio reported to the crew that local weather was: “wind variable at 5, visibility 14 scattered 012 charlie bravo, broken 120 overcast 280, temperature 26, dew point 25, altimeter 2973.”

Although Chuuk essentially was VMC, a single storm cell — the “scattered charlie bravo” — was moving around in the area. During the approach sequence, the cell moved between the MAP and the runway threshold. Thus, the approach would be conducted in VMC until the aircraft reached the MAP. As we’ll see, the crew ultimately

continued the approach beyond the MAP and slipped into IMC. Here are the highlights:

23:11:25 (09:11 local): The copilot reported passing FL 180 to San Francisco Radio.

23:15:59: Fifteen nm from Chuuk while passing 8,600 ft., the copilot made an inbound broadcast call stating their intention to track to the RNAV (GPS) Runway 4 from the east southeast. Moments later, the copilot contacted San Francisco Radio, and reported passing 8,000 ft. on descent.

Prior to commencing the approach, while descending through 4,000 ft., the PIC stated, “Alright, the missed approach is . . .” and the copilot did not respond. The PIC did not continue his statement/question with respect to the missed approach briefing.

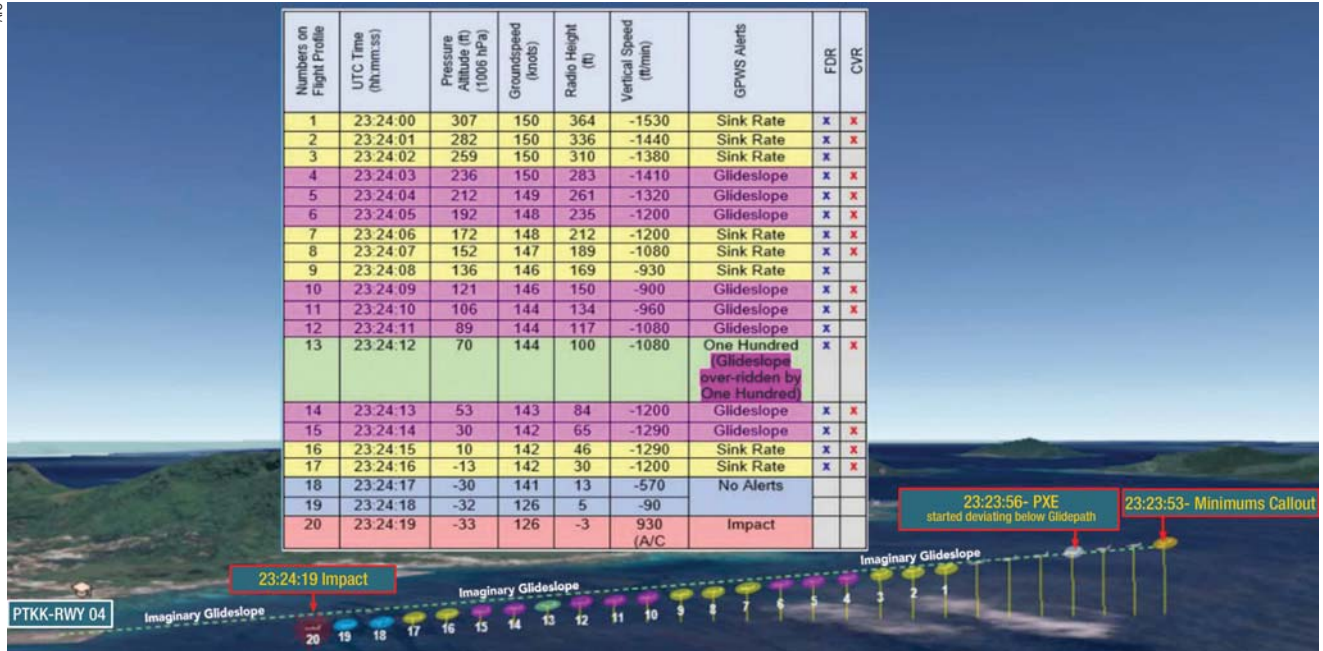

Glideslope and sink rate aural alerts graphic plotted using derived data.

23:20:53: The PIC stated to the copilot: "OK, we're on RNAV at 041 and I'll go 1,000." Shortly afterward at 23:21:07, the copilot made a general broadcast, stating that the flight was established on 041 inbound via the RNAV (GPS) Runway 4.

23:21:27: The PIC called for gear down and flaps 15 and stated, "We just configure as we can. . . ." Again, the PIC did not complete his instructions to the copilot.

23:22:33: The copilot mentioned to the PIC that there were some showers in the area and the PIC acknowledged by stating, "That must be some storm, but it'll be out soon." (The cell returns were red on the airborne weather radar.) The PIC called for the landing checklist, but the only callouts made by the copilot were for landing gear, flaps, and lights and runway in sight.

23:22:42: The PIC said to the copilot: "Ah, we'll probably just go down on the PAPIs." Seven seconds later the PIC said, "Alright flaps 30, flaps 40."

23:22:54: The PIC said, "Landing checks."

At the EGPWS 1,000-ft. altitude callout, the copilot told the PIC, "OK, stable." Four seconds later the PIC said, "Continue." The copilot then said, "and visual, 900 cloud base."

23:23:41: The copilot set the missed approach altitude on the mode control and shortly afterward, when passing 625 ft. (677 ft. radio altimeter), with the aircraft above the 3-deg. glideslope, the PIC disconnected the autopilot and

stated, "I'm going back on profile."

23:23:43: While passing 548 ft. (602 ft.) on descent, the aircraft entered a storm cell and heavy rain and the PIC called for the wipers to be activated. (The PIC stated during the investigation interview that he had already made the decision that it was visual up ahead with the runway edge lighting to continue for landing at that stage.)

23:23:49: The PIC said, "OK, landing."

23:23:52: The copilot said, "Visual, one red" (pause) "three whites."

23:23:53: EGPWS electronic voice called out "MINIMUMS."

23:24:00: As the EGPWS called out "SINK RATE, SINK RATE" the PIC said, "I just wanna get on profile" (over the top of the last "SINK RATE").

23:24:03: The EGPWS called out repeated "GLIDESLOPE, GLIDESLOPE, GLIDESLOPE."

23:24:06: The EGPWS callout repeated "SINK RATE, SINK RATE," and the PIC said to the copilot, "That's fine, I'll just go a little bit more."

23:24:09: The EGPWS callout repeated "GLIDESLOPE, GLIDESLOPE."

23:24:11: The copilot rapidly asked, "See the runway?"

23:24:12: EGPWS called out "100 GLIDESLOPE" and the PIC said, "Monitor airspeed. OK got it." (The FDR recorded a "GLIDESLOPE" alert, but it was overridden by the EGPWS "100 ft." call and was not recorded on the CVR.)

23:24:13: The EGPWS called out repeated "GLIDESLOPE."

23:24:17: The EGPWS called out "SINK RATE, SINK RATE." The copilot called rapidly with high intonation:

"Too low! We're too low! We're too low! We're too low!"

The airplane impacted the lagoon surface 2 sec. later.

The Investigation

The AIC began its look at the situation with the copilot's use of the Boeing EFB. Boeing's OPT EFB software was designed to assist pilots with takeoff and landing performance calculations by taking inputs for aircraft, runway and weather data and calculating expected airplane behavior. When Air Niugini purchased the OPT, Boeing provided unique, aircraft-specific configuration data for all of Air Niugini's Boeing fleet.

The copilot used the Boeing OPT to calculate the approach and landing performance. The crew's decision for the selection of flaps 40 was solely based on the Boeing OPT calculation done by the copilot on his EFB. The PIC did not query the source and method used to calculate and determine these operational figures. He agreed without verifying the data or instructing the copilot to verify the data using an approved onboard performance document.

The Air Niugini Flight Performance Office had issued the Boeing OPT to 65 Boeing captains and F/Os for training only. The investigation determined that the copilot's use of the OPT was not in accordance with Air Niugini's Flight Crew Operating Manual (FCOM) and Standard Operating Procedures Manual (SOPM).

The use of the EFB diverted the copilot's attention from his primary flight

duties, said the AIC. The analytical and methodical procedures outlined in the SOPM and FCOM were overlooked during that time. The 150-meter landing distance buffer calculated from the EFB was not checked against the approved onboard charts and tables.

“The recorded information from the CVR revealed that the PIC’s tolerance and non-questioning of the copilot’s use of the EFB, and his subsequent adherence to the data derived from the EFB, was not in accordance with ICAO Annex 6 and the operator’s SOPM,” said the AIC report. “Therefore, both pilots based their approach and landing performance assessment entirely on the calculations from the Boeing OPT contained in the EFB.”

During the flight, before the top of descent (TOD) briefing, the oral communications between the PIC, the F/O and air traffic control were conducted in normal tones and in an orderly manner. “However, during the approach, below 10,000 ft., communication between the pilots was minimal and not in accordance with SOPs, and they were not using standard phraseology,” said the AIC. “The PIC’s intention to continue the landing was

reinforced when he asked the copilot to continue the landing checklist immediately prior to the EGPWS 1,000-ft. annunciation. However, the CVR indicated that the only items covered were landing gear, flaps and lights.”

The copilot did not provide effective monitoring and operational support to the PIC and did not recognize the unstable approach. The evidence showed that he was unaware of the developing unsafe conditions. “Due to his lack of situational awareness and vigilance, he was unable to recognize the need to correct the ever-increasing dangerous rate of descent below the glideslope,” said the AIC.

At the minimums call, the copilot stated “three whites” with reference to the PAPI indicating high above the glidepath. The aircraft was not on the correct flight path and the rate of descent significantly exceeded 1,000 fpm with the glideslope indicator showing a rapid deviation from half-dot low at the MDA, to two-dots high within 9 sec. after passing the MDA in IMC.

The pilots were not complying with Air Niugini SOPs and demonstrated that they were not situationally aware,

and that their attention was channeled. “Their actions indicated that they were fixated on a particular aspect and did not address the alerts and take corrective action,” said the AIC. “The PIC said that he found the Boeing 737-800 aircraft laterally less stable with flaps 40 compared with flap 30s setting, resulting in lateral overcorrections of the aircraft after he disconnected the autopilot.”

Both pilots stated during interviews with investigators that they disregarded the constant “GLIDESLOPE” and “SINK RATE” aural alerts.

Video footage of the cockpit NAV display taken by the cockpit jump seat occupant showed an area of heavy rain (cockpit radar returns) on the approach in front of the aircraft immediately after the MAP. The missed approach track was outside the boundary of the storm cell and rain. However, the storm cell was between the aircraft and its intended landing runway.

“If the crew had made the missed approach at the MAP,” said the AIC, “they would have avoided the heavy rain.”

The investigation determined that when the aircraft entered the rain, all

Accidents in Brief

Compiled by Jessica A. Salerno

Selected accidents and incidents in August and July 2019. The following NTSB information is preliminary.

► **August 5 — About 0940 EDT, a** Piper PA28 140 (N5915U) crashed during a forced landing following a loss of engine power on takeoff from the Miami Executive Airport (TMB), near Miami, Florida. The flight instructor, student pilot, and a passenger received minor injuries. The airplane sustained heavy wing and fuselage damage. The airplane was registered to and operated by Osorio Aviation Corp. as a Part 91 instructional flight. It was VFR in the area around the time of the accident. The local flight was originating from TMB at the time of the accident.

According to initial information given to the FAA, the flight instructor reported

that “everything” was checked before the engine was started. Thirty gallons of fuel was estimated to be in the fuel tanks and “some” oil was added to the engine. The engine was started, and the engine run up checklist was used to check the engine operation. About 200-300 ft. AGL, the engine started to shake. The flight instructor took over the flight controls. There was not enough runway to land straight ahead. The flight instructor attempted to turn the airplane to land on Runway 13 or 9R. The engine had a complete power loss. The airplane descended and subsequently had a hard landing on a corn field between Runway 9L and 9R.

► **August 3 — About 0910 CDT, a** Cessna A185 amphibian airplane (N5806J) conducted a forced landing about 14 mi. southwest of Saginaw, Michigan. The pilot and three passengers received minor injuries, and the airplane was heavily damaged. The Cessna was registered to and operated by a private individual under Part 91 as a cross-country flight. It was VFR at the time of the

accident. The pilot reported that during cruise flight, the engine experienced a loss of power. He selected a road for the forced landing; however, the airplane hit a power pole and electrical wires during the forced landing. Examination of the accident site revealed the airplane came to rest inverted, with substantial damage to the fuselage and both wings.

► **July 30 — At 1600 EDT a Cessna** 210E (N2362F) was heavily damaged while landing at Lovell Field Airport (CHA), Chattanooga, Tennessee. The private pilot and two passengers were not injured. It was VFR and no flight plan was filed for the flight that originated from Destin Executive Airport (DTS), Destin, Florida, about 1120 CDT, and was destined for Mark Anton Airport (2A0), Dayton, Tennessee.

According to the pilot, upon retracting the landing gear after takeoff from DTS, the amber gear-in-transit light would not extinguish. The pilot cycled the landing gear with the same result. He placed the landing gear handle in the neutral position and continued the flight. Upon arrival

visual reference, if established earlier, would have been lost. The PIC informed the AIC that visual contact with the runway was lost in the final 30 sec. of the flight.

“It is inconceivable that the PAPI or the runway were visible to either pilot as the aircraft was descending farther below the glideslope in the rain,” said the AIC. “From 307 ft. [364 ft.] the PFD displayed a red warning: PULL UP. That warning was generated by the EGPWS when the rate of descent exceeded a specified limit.

“However, under the circumstances where the PIC’s attention was channeled, and the copilot was not effectively monitoring the displays and was lacking vigilance, that visual cue PULL UP was missed by both pilots. There was no aircraft-generated aural hard warning to alert the crew to the approaching disaster.”

There was ample information available to the flight crew from the EGPWS alerts and warnings to alert the pilots that the approach was unstable and, therefore, a hazard existed, said the AIC. Company SOPS state, “If a deviation exists at or below the stable approach gates [1,000 ft.

AGL in IMC or 500 ft. AGL in VMC] the PM shall make the relevant deviation call followed by the word “unstable.” The PIC shall announce “Go-around” and an immediate go-around procedure shall be conducted.”

From the time the autopilot was disconnected at 625 ft. (677 ft.), the aircraft was never in a stabilized approach and, therefore, a go-around should have been conducted immediately. Yet, the copilot was completely unaware of the hazardous situation unfolding and did not challenge the PIC and did not attempt to take control of the aircraft from the PIC and execute a go-around, in accordance with company instructions that require taking over when an unsafe condition exists.

“The PIC’s actions were consistent with him being trapped in the condition called ‘fixated on one task’ or ‘one view of a situation even as evidence accumulates,’” said the AIC. “He intended to land the aircraft, and in doing so disregarded the alerts [EGPWS ‘SINK RATE’ and ‘GLIDESLOPE’] indicating an unsafe condition.”

The AIC hired an aviation medical practitioner who has specialized in

aircraft accident and serious incident medical and psychological investigations for more than 20 years. The expert examined all relevant evidence and provided the AIC with an assessment and findings. No evidence of fatigue was presented.

Inattention (or decreased vigilance) has been a contributor to operational errors, incidents and accidents worldwide, said the AIC. Decreased vigilance manifests itself in several ways, which can be referred to as hazardous states of awareness.

These include:

(1) Absorption: A state of being so focused on a specific task that other tasks are disregarded.

(2) Fixation: A state of being locked onto one task, or one view of a situation, even as evidence accumulates that attention is necessary elsewhere, or that the particular view is incorrect.

(3) Channelized attention: A mental state that exists when a person’s full attention is focused on one stimulus to the exclusion of all others. This becomes a problem when the person fails to perform a task or process information of a higher priority and thus fails to notice or

at 2AO, the pilot was unable to extend the landing gear while on approach to the airport. He declared an emergency and attempted to pump the landing gear down via the emergency gear-extension handle. The pilot was unable to pump the gear down and observed hydraulic fluid on the floorboards near the passenger seat. The pilot diverted to CHA and landed on Runway 20 with the nose gear down and locked and the two main landing gear partially extended. As the airplane decelerated it veered to the right, impacted a taxiway sign, and slid to a stop in the grass. The pilot held a private pilot certificate with a rating for airplane single-engine land. His last FAA first-class medical was issued on June 7, 2017. The pilot reported 123 total hours of flight experience at the time of the accident.

► **July 27 — About 1220 EDT, an**

amphibious, light sport Icon Aircraft A5 airplane (N663BA) was heavily damaged after hitting trees shortly after departure from Littlefield Lake, Lake, Michigan. The airplane was registered to and operated by Icon Aircraft Inc. as a Part 91 business

flight when the accident occurred. The Airline Transport pilot received minor injuries and the pilot-rated passenger was seriously injured. It was VFR and no flight plan had been filed.

According to the pilot, the purpose of the flight was a sales demonstration flight with a potential client. When he arrived at Littlefield Lake, he estimated the winds to be about 8 to 10 kt. from the southwest. After landing, he taxied to the client’s home and beached the airplane so the client could board. After taxiing the airplane to the selected departure area, he said the wind had increased and he estimated the speed to be between 12 and 15 kt. He said when he started the takeoff run, he saw three small wakes, consistent with those from wave runners, which helped propel the airplane into the air. He said that they got into the air on the first takeoff attempt. He said the takeoff was normal and “there was nothing wrong with the [air] plane at all.” He stated that they got to the shoreline, they were treetop height plus an estimated 50-60 ft. His plan was to execute a left turn to stay over

the lake in the event of an engine failure. Before starting the right turn, he looked at the angle of attack indicator and it showed one needle width below the top of the green, and he estimated his speed between 55-60 kt. He started to initiate a 10-deg. turn to the right to stay over the lake and it suddenly sounded like they “hit a wall.”

The pilot rated passenger, who was seated in the left seat at the time of the accident, stated that “the weather was not the best” and that the wind was shifting 180 deg. He said he told the pilot-in-command (PIC) this sentiment, and that it took four takeoff attempts to get airborne. After the second attempt, he said he told the PIC that it would not break his heart if they did not go. He said that the airplane felt very sluggish and acted as if it did not want to come off the water. When they did get airborne, they were about 100 ft. from the trees, headed straight toward them and the airplane “felt very heavy.” When asked to elaborate on the weight, he said the PIC told him they had 485 lb. available and only three-quarters of a tank of fuel. A post-accident

Cause & Circumstance

has no time to respond to cues requiring immediate attention.

(4) Fascination: An attention anomaly in which a person observes environmental cues but fails to respond to them.

(5) The “tunneling or channelizing” that can occur during stressful situations, which is an example of fixation.

The AIC said it chose the term “fixation” to describe the PIC’s state of alertness, which provides a clearer idea of “being locked onto one task” than does “absorption.” Several findings support this tunneling or channelized condition, for example:

► The PIC’s attention became fixated on landing the aircraft.

► The crew did not respond to 13 EGPWS aural caution alerts and the PULL UP visual warning. The PIC did not change his plan to land the aircraft, although the aircraft was in an unstabilized condition. The other tasks that needed the crew’s attention were either not heard or disregarded. The auditory information about other important and hazardous things did

not reach their conscious awareness.

► The PIC flew an unstabilized approach. His intention to continue to land the aircraft, from an excessively high rate of descent when in IMC and below the minimum descent altitude, was a sign that his attention was channelized during a stressful time.

► The PIC’s decision to continue in IMC past the MAP and not conduct the missed approach was flawed. In choosing the landing option rather than the go-around the PIC fixated on a dangerous option.

Formal Findings

The AIC issues a list of “findings” rather than determining a “probable cause.” Based on the preceding analysis, the AIC made these findings:

The investigation determined that the flight crew’s level of compliance with the Air Niugini SOPM was not at a standard that would promote safe aircraft operations.

The PIC intended to conduct an RNAV

GPS approach to Runway 4 at Chuuk and briefed the copilot accordingly. The descent and approach were initially conducted in VMC, but from 546 ft. (600 ft.) the aircraft was flown in IMC.

The flight crew did not adhere to the Air Niugini SOPM or the approach and pre-landing checklists. The RNAV (GPS) Rwy 04 Approach chart procedure was not adequately briefed.

The RNAV approach specified a flight path descent angle guide of 3 deg. The aircraft was flown at a high rate of descent and a steep variable flight path angle averaging 4.5 deg. during the approach, with lateral over-controlling; the approach was unstabilized.

The FDR recorded a total of 17 alerts, specifically eight SINK RATE and nine GLIDESLOPE. The recorded information from the CVR showed that a total of 14 EGPWS aural alerts sounded after passing the MDA, between 307 ft. (364 ft.) and the impact point. A “100 ft.” advisory was annunciated, in accordance with design standards, overriding one of the GLIDESLOPE aural alerts. The

Accidents in Brief

weight and balance calculation, based upon the most recent available weight and balance and information provided to a FAA safety inspector by the PIC, revealed that the airplane was about 70 lb. over max gross weight and outside of the weight and center of gravity envelope limits contained within Pilot’s Operating Handbook.

► July 27 — About 0535 MDT, a

Fairchild/Swearingen SA227-AC (N681TR) was heavily damaged during a runway excursion at the El Paso International Airport (ELP), El Paso, Texas. The pilot, copilot and observer were not injured. The airplane was registered to Sierra West Airlines, Inc. and operated by Pak West Airline dba Sierra West Airlines as a Part 91 instructional flight. It was VFR and no flight plan was filed. The local flight originated from ELP about 0430. The crew was unable to retract the landing gear after takeoff and received

indications of a hydraulic system failure. Unable to lower the landing gear, the left main landing gear subsequently collapsed during landing. The airplane departed the runway pavement and encountered an airport sign. The outboard left wing contacted the ground when the gear collapsed.

► July 24 — About 1420 MDT, a Beech

95-B55 (N8910U) hit trees and terrain about one-quarter mile north of Chadron Municipal Airport (CDR), Chadron, Nebraska. The pilot, pilot-rated-passenger and one passenger were killed and the airplane received heavy damage. The Beech was registered to and operated by the pilot under Part 91 as a personal flight. It was VFR at the time of the accident and an IFR flight plan had been filed. The flight departed Fond du Lac County Airport (FLD), Fond du Lac, Wisconsin, about 1120 CDT, and was en route to CDR.

Preliminary flight track data revealed portions of the accident flight from FLD to CDR. The first point was recorded 1.25 mi. northwest of FLD at 1,475 ft. MSL and heading west. The track continued generally west at a cruise altitude about

8,000 ft. MSL, until 1348 MDT when the track stopped about 22 mi. northwest of Valentine, Nebraska. At 1408 MDT the flight track resumed for less than 3 minutes during which time the altitude decreased from 8,125 ft. msl to 7,300 ft. msl and ground speed 174 kt. At 1417 the track resumed about 12 nm northeast of CDR with a transponder code of 1200 at 6,050 ft. MSL and 158 kt. ground speed. A witness stated that he observed the accident airplane in the traffic pattern on the east side of Runway 21. The airplane appeared to be on the left base leg for Runway 21 as it made a left turn. While in the left turn the nose suddenly dropped and the airplane descended behind the tree line.

Another witness, who was located 0.24 mi. northeast of the accident site, stated she heard the airplane overhead and the engine “sputtered” as if it lost power. She added that the sound from the airplane was a lot louder than the normal airplane traffic over her house.

An initial examination of the wreckage revealed that the fuel tanks were breached due to impact and there was no evidence of a fuel spill underneath the airplane. About 3 oz. of fuel was found

other aural alerts were seven GLIDESLOPE and six SINK RATE.

The investigation observed that the flight crew disregarded the alerts and did not acknowledge the “minimums” and 100 ft. alerts — a symptom of fixation and channelized attention. The crew were fixated on cues associated with the landing and control inputs due to the extension of 40-deg. flaps.

Neither pilot was situationally aware nor did either recognize the developing significant unsafe condition during the approach after passing the MAP when the aircraft entered a storm cell and heavy rain. The weather radar on the PIC’s navigation display showed a large, red area indicating a storm cell immediately after the MAP, between the MAP and the runway.

The copilot as the support/monitoring pilot was ineffective and was oblivious to the rapidly unfolding unsafe situation. He did not recognize the significant unsafe condition and, therefore, did not realize the need to challenge the PIC and take control of the

aircraft, as required by the Air Niugini SOPM.

The records showed that the copilot had simulator training for EGPWS alert TERRAIN; however, there was no evidence of simulator check sessions covering the vital actions and responses required to retrieve a perceived or real situation that might compromise the safe operation of the aircraft. Specifically a sustained unstabilized approach below 1,000 ft. AGL in IMC.

The PIC did not conduct the missed approach at the MAP despite the criteria required for visually continuing the approach not being met, including visually acquiring the runway or the PAPI.

The PIC did not conduct a go-around after passing the MAP and subsequently the MDA even though: The aircraft had entered IMC; the approach was unstable; the glideslope indicator on the PFD was showing a rapid glideslope deviation from a half-dot low to two dots high within 9 sec. after passing the MDA; the rate of descent exceeded 1,000 fpm and was increasing; there were EGPWS SINK

RATE and GLIDESLOPE aural alerts; and the EGPWS visual PULL UP warning message was displayed on the PFD.

“This report highlights that deviations from recommended practice and SOPs are a potential hazard, particularly during the approach and landing phase of flight, and increase the risk of approach and landing accidents,” said the AIC. “It also highlights that crew coordination is less than effective if crewmembers do not work together as an integrated team. Support crewmembers have a duty and responsibility to ensure that the safety of a flight is not compromised by noncompliance with SOPs, standard phraseology and recommended practices.”

The lesson here is clear. Once again, we see an unstabilized approach lead to loss of life and aircraft. All airline and most business aviation SOPs call for an immediate missed approach if the situation becomes unstable. And it should go without saying that once a crew finds itself back in IMC below minimums, it’s time to hit the TOGO button. **BCA**

in the right fuel strainer assembly. About 1 oz. of fuel was found in the left engine driven fuel pump supply line.

Seats 4, 5, and 6 had been removed from the airplane and the cabin and nose baggage compartment were both found packed with camping gear and other miscellaneous items. All items were removed from the cabin and nose baggage compartment and weighed for weight and balance calculations. The cargo in the cabin weighed 293.6 lb. The cargo in the nose baggage area weighed 116 lb.

► **July 24 — About 0550 EDT, a Cirrus SR22 (N921CD) was destroyed when it collided with terrain shortly after takeoff from Jimmy Carter Regional Airport (ACJ), Americus, Georgia. The commercial pilot and the pilot-rated passenger were killed. It was IFR, however, no flight plan was filed for the flight which originated from ACJ about 0547. The personal flight was conducted under Part 91.**

According to a friend of the pilot, the purpose of the flight was to attend the 2019 EAA AirVenture Oshkosh, in Oshkosh, Wisconsin. Preliminary radar data provided by the FAA, showed the

airplane’s radar track as five radar targets over a span of 1 minute, and the targets were 12 seconds apart. A line connecting each target as well as the accident site, depicted a 180 deg., left-hand arc.

According to a witness, his attention was drawn to the sound of an airplane engine about 0550. He said the sound of the engine was “whining” and “loud.”

According to FAA records, the pilot held a commercial pilot certificate with ratings for airplane single-engine land, airplane single-engine sea, and instrument airplane. In addition, he held an airframe and powerplant mechanic certificate. The pilot was issued a second-class medical certificate on January 11, 2019, with the limitation of “must have available glasses for near vision.” At that time, he reported 22,000 hr. of total flight time, 300 hr. of which were within the 6 months prior to the examination.

According to FAA airmen records, the pilot-rated passenger held a commercial pilot certificate with ratings for airplane single engine land and instrument airplane. In addition, he held an airframe and powerplant mechanic certificate. The pilot-rated passenger was issued a

second-class medical certificate on April 20, 2018, with the limitation of “must have available glasses for near vision.” At that time, he reported 1,850 hr. total flight experience.

The airplane came to rest on a pecan farm at an elevation of 477 ft., and all major components were accounted for at the scene. The wreckage path was about 400 ft. long oriented about a 180-deg. heading. The initial tree strike was observed about 100 ft. above the ground.

The Cirrus Aircraft Parachute System (CAPS) was examined, and the safety pin, with its “Remove Before Flight” banner attached, remained installed in the deployment handle. The parachute remained in its deployment bag, and the suspension lines and risers were draped over a tree in the direction of the main wreckage.

The 0550 recorded weather observation at ACJ, which was located about 2 mi. south of the accident site, included an overcast ceiling at 500 ft., and wind from 050 deg. at 5 kt. The visibility was 10 mi., the temperature was 22C, the dew point was 21C; and the altimeter setting was 29.95 inches of mercury. **BCA**



Is Sim Training Sufficient?

What you don't learn at the schoolhouse

BY FRED GEORGE fred.george@informa.com

We all know the drill. If it's Thursday, it must be hydraulic failures and no-flap landings. Same simulator session, different day last year, this year, next year. Every 12 months, or less, it's back to the schoolhouse to review the nuances of all our aircraft's systems, to run through the perfunctory weight and balance and performance computations, to hone our piloting skills during one-engine-inoperative emergencies.

There are wind-shear encounters, an occasional blown tire, smoke in the cockpit and simulated rapid decompression events. We circle to land at night in low ceiling and visibility conditions at Memphis and JFK. Close your eyes for a few moments at altitude while we put the sim into some unusual attitudes; then open them on command, recognize and recover. Unload, roll, pitch, power and reestablish normal flight.

Decades of rote practice yield predictable results. With few exceptions, corporate aviation remains one of the safest and most secure modes of travel yet invented. But does FAR Part 142 sim training prepare business aviation pilots for everything they're likely to encounter in day-to-day operations?

We wanted to discover if we were missing anything. So, this year, we elected to take a different approach to refresher training, one that would supplement rather than replace our usual sim training. We called Leading Edge Aviation's flight school, the local Part 141 fixed-wing and helicopter pilot training operation at the Bend, Oregon, Municipal Airport (KBDN), and scheduled an FAR Part 61.56 flight review with Riley Harris, chief fixed-wing instructor. Bend currently is an uncontrolled airport, but it's on the list of landing facilities where a tower soon will be installed, Harris says. There are about 500 airports with control towers in the U.S. and close



Want complexity? Try operating out of a terminal area with part-time control towers and approach control, as noted in the Chart Supplement. There are plenty of potential traps and pitfalls associated with arriving at, and departing from, airports in the Greenville-Spartanburg terminal area after hours.

to 4,500 others without towers that can be used by business aircraft.

In preparation for ground and flight instruction at Leading Edge, we purchased King Schools' bundle of online flight review training courses, including communications procedures at both controlled and uncontrolled airports, regulations and airspace reviews, and pilot medical requirements. Within an hour of starting the online courses, it was apparent that we were quite rusty on many of the basics covered by John and Martha. A follow up conversation with the Kings, mainly focusing on risk identification and risk management, also uncovered gaps in standard FAR Part 142 training syllabi that we'll discuss later in this report.

The more we probed into the basics taught during initial private, instrument and commercial pilot training, the more questions came to mind

about topics not covered during our sim training sessions. We started to discuss the topics with several flight instructors and soon learned that at issue were omissions during ground school reviews rather than commissions of errors in the sim.

Airspace Alphabet Soup

Sim training typically assumes you're departing from and landing at Class D tower-controlled airports having a full suite of services including ATIS, clearance delivery and ground control. Between airports, you're in radar and radio contact during departure, en route and arrival phases of flight.

But that's not the everyday flying experience for many business aircraft operators.

Cody Downey is a Bombardier CRJ captain for a regional airline in the

FLYING CHARTER? DO YOUR DUE DILIGENCE.

LOOK FOR THIS LOGO!



Registered operators who have successfully completed the independent ACSF Industry Audit Standard meet the highest standards for safety and security in the on-demand charter industry.

Brought to you by these ACSF audit-registered operators:



...and these ACSF members:



Southeastern U.S. who uses his FAR Part 121 experience to inject reality as an independent flight instructor. He invited us to look closely at the airports and airspace near Greer, South Carolina's Greenville Spartanburg International Airport (KGSP), a landing facility regularly served by his company. Virtually every trip he flies is on an IFR flight plan, but he notes that there's plenty to be gleaned by looking at the symbols, graphics and abbreviations on VFR sectional charts. A star next to the control tower frequency and/or aircraft lighting symbol, for example, denotes part-time operation.

KGSP is cosseted in Class C airspace as shown by the magenta rings and lines around the airport. While the tower is open from 11:00Z to 04:45Z, aircraft are provided communications and radar approach control services. Downey's air carrier also uses the airport outside of those hours, as might a business aircraft operator.

The Chart Supplement, formerly called the Airport/Facility Directory, provides essential information regarding runway and taxiway weight bearing capacity, continuous and pilot-controlled runway lighting, ground services available, operating restrictions and ATC services.

From 04:45Z to 11:00Z, for instance, the Chart Supplement shows that KGSP reverts from Class C to Class E airspace. The tower frequency becomes a common traffic advisory frequency used by all aircraft to communicate their position and intentions. ATC still controls IFR aircraft, but VFR aircraft are free to operate on their own as long as pilots respect VFR weather minimums — 3 sm visibility, while staying 1,000 ft. above, 500 ft. below and 2,000 ft. horizontally clear of clouds. Those cloud clearances, Downey notes, are intended to prevent nasty surprises should an IFR aircraft pop out of a cloud in close proximity to a VFR aircraft. However, extra vigilance is warranted as VFR aircraft aren't likely to be on the same radio frequency as IFR aircraft unless their pilots are using ATC VFR flight following. The Chart Supplement indicates that Atlanta Center provides IFR arrival and departure control services while Class E airspace is in effect.

Prior to departure while you're still in the chocks, it may be necessary to contact Anderson Radio (FSS) on the frequency shown on the Sectional Chart or in the Chart Supplement to request

and read back your IFR clearance. Anderson Radio functions as a relay station between ATC and the aircraft. Downey also notes that pilots can phone (888) 766-8267 for clearance delivery when departing from a non-tower-controlled airport if they're unable to make radio contact.

Greer isn't the only airport under or near the GSP Class C airspace to have a part-time control tower or no control tower at all. Greenville Downtown Airport (KGMU) to the southwest of Greer is a Class D tower-controlled facility from 12:00Z to 03:00Z. Other times, it reverts to Class G uncontrolled airspace up to the 700-ft. AGL floor of Class E airspace.

Greenville Donaldson Field (KGYH) is another part-time Class D facility with different operating hours that is located just outside of Greer's Class C perimeter. VFR aircraft departing Donaldson when both Greer and Donaldson are closed for the evening could overfly Greenville-Spartanburg Airport without talking to anyone.

Parker, Chandelle, Green Pond, Spartanburg, Pearson's Farm, Fairview and Mountain Ridge are among several small uncontrolled airports in the area where VFR pilots are free to operate in Class E airspace while Greenville-Spartanburg's Class C airspace is inactive. Downey says see-and-avoid vigilance is vital even with the best TCAS II equipment.

Memo to self: Time for follow-on computer-based-training airspace refreshers, even after completing a 24-month flight review or Part 142 sim training.

Scenario School

Several instructors we contacted say they use scenario-based training to encourage pilots to use creative problem solving. This starts with changing payload or fuel requirements by adding passengers or imposing challenging weather conditions after pilots make the initial weight and performance computations. Many times, this requires extra fuel reserves. Heavier loads have an impact on takeoff and climb performance, requiring pilots to assure that the runway is long enough and that there will be adequate clearance over obstacles in the departure path.

Departure delays may be part of the scenario. If it will be warmer or if forecast winds dictate a change of runways, such conditions potentially could reduce

maximum allowable takeoff weight to meet performance requirements.

Actual en route weather and winds often vary significantly from forecasts. Some instructors inject scenarios with changes in winds or weather to challenge pilots' judgment and decision-making capabilities. For long-distance missions, unforecast headwinds could dictate a diversion for refueling. Instructors often toss in challenging weather conditions at the diversion landing facility to evaluate both judgment and piloting skills.

En route engine, systems or medical emergencies can be far more challenging than the usual Part 142 drills near airports. These scenarios require pilots to choose the most suitable divert field based on the nature of the emergency, en route weather, conditions at the landing facility and ground support services, including the proximity of emergency medical facilities.

Dynamic arrival conditions seldom are encountered during the usual sim training. But they're regular fare during scenario-based training. Severe weather may require extended holding or even diversion to a suitable alternate.

Marty Wymond, also an independent CFI based in California's San Joaquin Valley and who regularly flies Cessna Citation CJs, says he emphasizes loss of control risks during 24-month reviews of pilots. He notes that mild overshooting crosswinds are especially insidious, as pilots may not realize the effects until they're turning base to final, particularly when flying tight traffic patterns. He points out that several business jet accidents have resulted from stalls caused by pilots trying to salvage overshooting approaches to final.

Wymond also says that situational awareness around crowded, uncontrolled airports is challenging for pilots. He notes that business jets are just as bound by VFR traffic pattern entry rules as Piper Cubs. It's essential to announce your position and intentions, overfly the airport at 1,000 ft. above pattern altitude, if approaching from the downwind side and make adjustments as required for other aircraft in the pattern. Straight-in approaches should be reserved for IFR arrivals. Circling approaches should use left patterns, unless otherwise stated in the Chart Supplement. But once you break out of the clouds and cancel your

instrument flight plan, you're required to abide by VFR traffic pattern rules. And at airports without operating control towers, some light aircraft may not even have communications radios, so see-and-avoid is survival.

Risk Management

John and Martha King say that risk management isn't emphasized at the schoolhouse. "During sim training, you don't make risk management decisions. You demonstrate systems knowledge and airmanship skills," says John. "We've been to [sim training] 35 times, so there's very little that comes as a surprise. Yet, risk identification and mitigation strategies are the most important part of flying."

The Kings say that operations at uncontrolled airports are among the most challenging because pilots are free to choose any runway, if the winds are near calm and there is no published favored runway. Indeed, during sim training, you're usually the only "aircraft" operating in a specific block of airspace and at a particular airport. But the lack of other traffic on frequency and in typically congested airspace is quite abnormal. The occasional TCAS resolution advisory might be the only clue that there are other aircraft in the sky.

Risk management starts prior to flight with the four-way PAVE matrix invented by the Kings and now embraced by the FAA. Pilots need to evaluate their fitness for flight, including fatigue, use of prescription medications, emotional stress, illness and lack of recent experience. Aircraft factors include unfamiliar gear aboard the aircraft, such as FMS, EFIS and other avionics that have been added as after-market equipment, and minimum equipment list exceptions. EnVironmental factors, such as unfamiliar airspace or airports, mountainous terrain or obstacles and weather conditions need to be reviewed. And, perhaps the most urgent, External pressures need to be identified and mitigated.

"Pilots are goal-oriented people. That's great for you as an entrepreneur, but it can kill you as a pilot," says John. "A goal-oriented person in the cockpit is the biggest risk in an airplane. We need to teach pilots to manage their own pressures, try to mitigate risks before launch. We say,

pack a suitcase even if you're only going for a \$100 hamburger." In the case of the Kings' Falcon 10, that's indeed a very short flight.

"The pressure to complete the flight increases the closer you get to the destination. Winds and weather, both en route and at the destination, are constantly changing," says John. "You need to force yourself to make a fuel stop, if you have low reserves," says Martha. "Risk management training is the biggest opportunity you don't have at an FAR Part 142 school," John adds.

AQP and Continuous Learning

Downey says his company has an Advanced Qualification Program (AQP) that emphasizes training to proficiency rather than logging a set number of classroom sessions and sim flight hours. Many air carriers have embraced computer-based training (CBT) courses as a means of honing systems and company procedures knowledge. CBT courses emphasize scenarios that more closely replicate real-world conditions that have led to most fatal accidents.

TRU Simulation and Training, Textron's Part 142 training company, has been in the forefront of providing continuing CBT flight crew training. Every two weeks since I underwent a CE525 single-pilot type rating course at its Carlsbad, California, facility, I've received an email push with a multiple-choice systems quiz. Clicking on any of the four answer choices automatically pulls up a web page that not only grades my response but provides an animated graphic and voice explanation of why the choice was correct or incorrect. The TRU system also prompts me if I want one or more subsequent system quiz questions. The goal is to prevent clients from getting rusty on systems knowledge between visits to the sim training centers.

CBT education systems, similar to the automatic TRU aircraft systems quiz email push, have great potential for expansion into other knowledge areas. There are opportunities to include airspace refresher courses and compliance with complex ATC clearances, both VFR and IFR operations at uncontrolled airports, airport signage and markings, right of way rules, risk identification and management, the new ADS-B rules and a general review

of regulatory requirements. Most of these topics are covered during online video courses, such as the flight review programs from King Schools and other online ground school service providers. But in contrast to TRU's CBT education systems, most online courses are not self-paced and not accompanied by spot quizzes to check learning progress.

Our ground school review with chief instructor Harris verified a basic level of knowledge required for safely operating a single-engine aircraft in several classes of airspace. The flight review portion confirmed proficiency in a Beech F33A.

More importantly, the Part 61.56 ground and flight review sessions we undertook raised many questions about what is missing from typical Part 142 training programs. Many training companies offer aeronautical knowledge enrichment handbooks to peruse, but the texts are not as compelling as online training courses or even live classroom instruction.

The flight review session, including interaction with other aircraft at an uncontrolled airport, was quite a contrast to the sterile Part 142 sim session environment. There were dynamically changing weather conditions that would have required a diversion to neighboring Redmond's Roberts Field (KRDM), if we had been airborne 30 min. longer. The sky became progressively darker and more ominous as we entered the landing pattern. Fortunately, our fuel plan included generous reserves that afforded plenty of options to divert, if weather conditions deteriorated.

Large drops began to plop on us as we tied down the airplane after the final landing back at Bend. Lightning, wind gusts, heavy rain and even a hailstorm occurred during the debrief session at Leading Edge Aviation. The hour-long flight review was scenario-based training on-the-fly, with the constant need to reassess weather conditions and make decisions to continue our original flight plan or to divert to the alternate.

The flight review ground and flight instruction sessions, using a Beech Bonanza, were far simpler than operating a turboprop or a jet. But they served to remind us that while Part 142 sim training is essential, it's clearly not all-encompassing instruction for safe flying. **BCA**

My Gulfstream G500 Initial

Reinventing how we train



JAMES ALBRIGHT/BCA

A Gulfstream GVII-G500 cockpit

BY **JAMES ALBRIGHT** james@code7700.com

My first impression of the latest Gulfstream's cockpit was that it looked like the work of a luxury automobile maker, rather than that of the business jet builder responsible for most of the flight hours in my logbook. Quite simply, the flight deck of the Gulfstream GVII-G500 is a work of technological artistry.

The space has very few mechanical switches, and glass abounds. The four large display units up front will look familiar to pilots familiar with the G450, G550 or G650. But almost the entire overhead panel is replaced with three large overhead panel touch screens (OHPTSs). There are no flight management system (FMS) or radio control heads. Those and many other conventional interfaces have been replaced by five touch-screen controllers (TSCs). To cap it all, there are two large standby flight displays (SFDs) up high, where the pilot needs them, and these are automatically programmed and have more functionality than the primary instruments of many of the airplanes I grew up flying.

In short, this is a flight deck for the iPhone generation. And while I am somewhat removed from that generation, I am quickly catching up. I discovered that getting up to speed with the latest Gulfstream is a matter of adapting old philosophies with new.

Philosophy One

My company has been operating Gulfstreams since the G-IV and I have been flying them since the G-III. Or is that the G-1159? The disconnect between Gulfstream aircraft names and pilot type ratings has been with us from Day One. The original Grumman "Gulfstream" turboprop carried the type rating G-159. The "Gulfstream II" and later "Gulfstream III" became known as the G-II and G-III, respectively, though both carried a G-1159 type. Since then, many of the aircraft have had what I call hyphen confusion. The G-IV type rating works for the G-IV or GIV, depending on what publication you're reading. (Please not a G4!) The G-V first worked for the G-V aircraft, and later for the G-450 and

G-550. All of these aircraft lost their hyphens over the years, but the type ratings retain them: G-159, G-1159, G-IV and G-V. In 2009, the hyphen was officially banished with the G650 and the GVI type rating.

Throughout that evolution, we Gulfstream pilots understood that every Gulfstream was built on the aircraft that preceded it. The company philosophy was clear: If it doesn't work, replace it; if it does work, improve it. And Gulfstream embraced the philosophy of redundancy. The best example of that would be direct current (DC) power production in the G-V series. There are four major DC electrical buses, but there are five transformer rectifier units (TRUs) to produce it. One TRU is constantly powered but delivering power to no bus; it is the "pinch hitter" always ready to step in when called upon. You name the system, in most Gulfstreams redundancy is the prime directive in aircraft design. That's why most Gulfstream pilots will tell you their aircraft are built like tanks.

Two years ago, the CEO of my company asked me for an opinion of the "Gee-Seven." I didn't have one so I arranged a visit to Savannah, Georgia, to find out. The GVII type covers the G500 and G600, two aircraft that are nearly identical except for their size. The G500 is 91 ft., 2 in. long with a wing span of 87 ft., 1 in. The G600 is 96 ft., 1 in. long with a wing span of 95 ft. Gulfstream makes it clear that the GVII is a "clean sheet" airplane and I discovered that to be true in more respects than the obvious. Yes, the fuselage is wider than the G550's and earlier models' but not as wide as that of the G650. Yes, the wing is completely new (and gorgeous).

But the GVII reinvents many concepts that are not only new for Gulfstream but new for any aircraft built by anyone. The fly-by-wire (FBW) sidesticks, for example, are not the sidesticks you will find in a Falcon, Airbus, or even an F-16 fighter. They are better. These active control sidesticks (ACSS) provide

feedback to the pilot by moving in response to control feel, autopilot actions, and even the other pilot's inputs. Since ACSs didn't exist, Gulfstream had to invent them.

What about those touch screens? Fighter pilot friends of mine complain about screens that are too large to press accurately because their hands could not be braced against a nearby object, and that it was too easy to make a mistake with a glancing touch on the wrong part of the screen. Gulfstream wanted a glass with two modes, one for the swiping motion familiar to iPad and iPhone users, as well a surface that required a tactile and definite depression to activate critical switches. The glass didn't exist, so the airframer invented it. And all the touch screens are sized so that the hand can be anchored to one side while the pressing or swiping motion is made. That was two questions answered, but there were many more.

I started with a list of 20 doubts about this new technology, and one-by-one members of the Gulfstream design team convinced me that they got it right. So, they designed a good airplane, but was it worth upgrading from what we already had? Our Gulfstream G450's most frequent overseas destination is France. The G500 would get us there 45 min. faster while using less fuel. So, where do I sign?

I returned home and told my CEO that not only was the G500 the right airplane for our company, but that no other airplane being built today could compare to it in terms of safety and capability. While all other new aircraft on the market today are evolutionary in design, this one was revolutionary. We placed our order and take delivery later this year.

Now I had to worry about training three pilots to fly it and a mechanic to maintain it. I will write in the future about the purchase and delivery processes. But I just finished G500 initial pilot training and want to give a current assessment about the program designed by FlightSafety International in Savannah. As I write this the first 20 G500s have been delivered to rave reviews. Gulfstream can build them, but could FlightSafety teach pilots to fly them? I enrolled in Class No. 10 to find out.

Back to School

I have a theory about all aircraft initial courses that holds the amount of instruction expands or contracts to the time allocated while the subject

matter tracks whatever is trendy at the time. Twenty years ago, I thought my Bombardier Challenger 604 initial spent too much time on systems while ignoring the FMS. "You will learn that in the field," I was told. A few years later, my G-V initial seemed to emphasize systems over stick and rudder. In the G450/G550, the FMS took center stage at the expense of the other systems. In all three cases, we had 24 days to learn, not a day more. I showed up to G500 initial thinking FlightSafety would need to strike just the right balance for me to walk away with a type rating. (I don't learn as quickly as I used to.)

Learning a new airplane has always been one my favorite things to do, and I have been doing it for a long while. I was in U.S. Air Force pilot training exactly 40 years ago and after completing Cessna T-37 instruction, moved on to the Northrop T-38, the supersonic jet the Air Force called the Talon, but which we pilots called "The White Rocket." In the years that followed, I went back to "initial" training many times and have come to expect a certain pattern to repeat.

First, you sit down in class to learn the aircraft's limitations and systems. While the former was an exercise in rote memorization, the latter was useful for those of us with mechanical minds. You don't really need to fly an airplane to learn how the air-conditioning system works. You can teach me what I need to know about an engine with a chalkboard and a few slides. Once that is done, you hit the simulators if you have them, the flight line if you don't. There was always a distinct break between the classroom and the cockpit.

This old school mentality also meant you didn't actually need pilots to teach ground school, and if you used real pilots, they didn't have to be the best. One of my Challenger 604 instructors was a retired military pilot who had never flown any aircraft that didn't have "Navy" painted on the side. My first G-V instructor had never flown any Gulfstream other than the simulator. Once you graduated from ground school you were strapped into a cockpit and started flying. Depending on the airplane, the emphasis would be on stick and rudder skills, instrument flying or programming all the electronic gizmos. But you never got all three.

Reading ahead in our course material, I realized that learning the GVII was going to require a new type of teaching. The airplane is, in a word, holistic. Everything is related to everything else.

You cannot talk about the air-conditioning system, for example, without also considering cockpit avionics. The auxiliary power unit (APU), for another example, has a relationship with the inertial reference units (IRUs). I looked in vain for a flight management system (FMS), communications suite, or even a way to turn all those glass screens on or off. It became clear that the instructor was going to have his hands full with me. I was starting to wonder if 63 years of age was too old for this dog to learn new tricks.

Fortunately, FlightSafety was in on the ground floor with Gulfstream when the GVII was little more than crayon drawings on a large blank sheet of paper. When I first started seeing FlightSafety instructors wearing black golf shirts with "G500 Initial Cadre" on the sleeve I thought it was simply a collection of senior instructors lucky enough to win the favor of the center manager for the first class. I later found out that these were members of the "Design Build Team." Not only would they help design the aircraft but also the simulators and the course designed to teach it all. I quickly discovered that these initial cadre members were the best FlightSafety had to offer, and it showed.

Day One in school was with retired U.S. Coast Guard Pilot Ken Norris at



FlightSafety G500 instructor Ken Norris in class

the helm. At his side, every day in the classroom, was another accomplished instructor, Daniel Gomez. Yes, two instructors for one class. Norris was able to weave seamlessly from one subject to the next because Gomez had everything teed up perfectly as it was needed. This is crucial because every subject in this airplane is related to every other subject.

As a longtime Gulfstream pilot, I saw similarities in some of the systems but much of what I knew was not relevant. "Forget about your first love," Norris cautioned, asking us to abandon

previously held knowledge that no longer applied. We were a class of 24 students. Very few of us had any FBW experience. About half had never flown a Gulfstream of any type. Four spoke English as a second language. But none of us had ever flown anything like the GVII.

The topics for each hour of the first day seemed to be picked at random. We never finished a topic having fully grasped the subject; I was always left wanting more. “This is going to make sense,” Norris assured us. “You have to get through the complexity to find the simplicity.” It was as if he was saying, “Patience, grasshopper.” But with things like this, I rarely have patience. I want it now! Before we even scratched the surface of the systems, we were programming our first flight plan.

Each desk included a working mockup of the cockpit on a large monitor that allowed students to view and manipulate every cockpit control. To our right we had a cursor control device (CCD) to manipulate the forward cockpit displays. (These CCDs will be familiar to G450, G550 and G650 pilots.) Just on top of the CCD we had a touch-screen controller (TSC). To our left was an active control sidestick (ACS). In short, we had everything we needed to fly.

“Nobody go flying yet!” Norris warned. “Right now, you need to get familiar with the TSC. We’ll go flying tomorrow.” Flying on Day Two? This was happening fast. On Day One we had barely scratched the surface of several systems while learning a heavy dose of cockpit avionics. This was not how this is usually done! Norris ended the day by posing a series of questions for what he calls the “Exit Ticket.” Each student got several chances to cover the territory gained from the day. I felt fortunate to answer my questions correctly even as I had to admit I got some of the other students’ questions wrong.

Our study materials included a client’s guide complete with homework and an interactive cockpit called iFlightDECK designed for our iPads. (If you don’t have an iPad, FlightSafety will give you one.) The iFlightDECK includes a textbook of sorts; I found it wanting when compared to most eBooks but it does contain a wealth of knowledge. The cockpit displays in iFlightDECK are very helpful for practicing with the avionics.

Just as the previous day ended with Exit Tickets, the next morning began with “Bell Ringers” designed to ensure each student had a grasp of the ground

covered and was doing the previous day’s homework. By the end of the first week, we had learned to accomplish everything needed to program an instrument flight plan, start engines, take off, shoot an instrument approach, land and shut down. Our systems knowledge was on the rise. Somehow, despite my doubts about the teaching method, we were learning.

As a lifelong student of the learning process, I was gaining knowledge of the airplane even as I attempted to learn about this new method of instruction. We could no longer parse the airplane system by system; rather, we had to somehow learn it all at once. After the first week I figured out why: The Gulfstream philosophy had gained a new tenet.

Philosophy Two

The GVII retains the Gulfstream redundancy philosophy but adds another: automaticity. If you can relieve the crew of routine tasks, you free the pilots for more important duties. This has been true of all Gulfstreams to a lesser extent. Take the task of programming an airplane’s pressurization system, for example. G-IV and earlier pilots had to program their pressurization systems with the cruise altitude, climb and descent rates, landing field elevation and altimeter settings. This is simply entering information that exists somewhere else in the cockpit but is not obtainable by the pressurization system. Mistakes meant a failure to pressurize, depressurize, or worse. G-V and later pilots were relieved of this task because the FMS — which already knew the cruise altitude, field elevation and altimeter setting — would program the pressurization system automatically.

This ongoing quest for automatic-

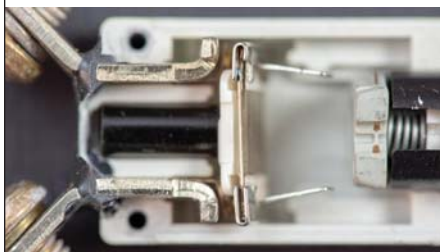

A conventional “hard” circuit breaker

ity was extended to other systems but was limited by physical switches. The computers didn’t have the ability to press, turn or toggle the many physical switches needed to operate the airplane.

All that has changed in the GVII, and to understand why, consider the humble circuit breaker.

A typical mechanical circuit breaker is nothing more than an on/off switch with a temperature-sensitive strip or disc of metal that is bent into one shape and has the property of popping its shape at a certain level of current, thereby throwing the spring-loaded switch off and breaking the circuit. It is not very useful as a switch, since repeated actuations will eventually weaken the metal disc, the spring and other internal components. Each circuit breaker takes up valuable panel real estate, and with the wires needed to connect from power sources to components, having a mechanical circuit breaker is a physical burden on the airplane. It also requires a human being to pull or push it, as well as find it in the first place. Finally, the hardware version of a circuit breaker isn’t very accurate. The break point of the metal disc is subject to changes in the ambient temperature, age and repeated use. Even when brand new, a physical circuit breaker has a wider tolerance than many of today’s sensitive electronics should have to endure.

A “virtual” circuit breaker is essentially a transistor that can make or break two wires based on the status of a third. It can be an electrical component or part of a circuit etching in a microchip. These virtual circuit breakers have been in use for many years in an attempt to reduce weight, increase the accuracy of circuit protection, and to free up panel real estate. But they have another virtue that not all aircraft use to full advantage: They make for very efficient switches. For an example, let us consider the very mundane task of starting an APU prior to engine start.

In the last few Gulfstreams I have flown, the routine to get the APU on line is the same: Turn on a master switch so as to complete a computerized built in test (BIT); do a fire test; turn on a fuel boost pump; turn on the airplane’s navigation lights; and then press a start button. Why can’t that be automated? On most airplanes the fuel pump and navigation lights switches are physical switches. In the GVII they are controlled by virtual circuit breakers called solid-state power controllers (SSPCs). Hitting the APU start button allows it to activate the fuel pump, turn on the navigation lights, start the APU, turn on most cockpit displays, open the system’s bleed air, and place the IRUs into navigation mode.

This automaticity philosophy means that repetitive tasks that do not require a pilot's active decision-making are handled automatically. Pilots are given control of the components if they want it, but for the most part it just takes care of itself. The learning challenge is coming to grips with having everything "just happen" while learning how to take control if you need it. Pilot-to-airplane interfaces are handled by three overhead panel touch screens (OHPTSs) and five touch-screen controllers (TSCs) spread throughout the cockpit. The result is a cleaner look while further increasing redundancy. Any one OHPTS can do the work of all three and the TSCs are swappable.

Getting in Touch With the Airplane

After a week of classroom and learning from our desks, it was time to get hands-on with a flight training device (FTD) that has synthetic displays of the entire cockpit, providing a chance to fly from takeoff to landing and to explore normal and abnormal procedures. The FTD is so good that the FAA allows pilots to log time at the controls. While we students yearned for actual time in the full-motion simulator, our instructors kept letting us know that this was a building block approach. We would get there.

Days in the FTD were mixed with more days in the classroom, each feeding off the other. Learning the finer points of each aircraft system became easier as our confidence with the OHPTSs and TSCs grew. I felt I knew most of the systems well enough to pass a check-ride oral, just a week and a half into the program. The one exception was the flight control system.

As noted, and like many of my classmates, I had no experience in FBW technology and thought that subject would take up most of the instruction. It did not. The active control sidesticks are designed to mimic conventional controls where that is best, and to improve upon the stick and rudder found on the airplanes I had flown with a stick, cables and pulleys. I have about 1,000 hr. flying with a stick, but not a sidestick. I thought perhaps this would be a problem; it wasn't. Consider your left arm on an ergonomically designed armrest, trying to move a stick in four directions. Pulling back is easier than pushing forward. Moving the stick inboard is easier than outboard. The active sidestick takes all this into consideration. Even

my classmates with no stick time at all adapted very quickly.

Each flight control surface has multiple sources of hydraulics and electronics driven by multiple actuators and computers. Should all of that fail, every surface except one pair of spoilers also has an electric backup hydraulic actuator that doesn't need airplane hydraulics or the usual assortment of computers.

A typical business jet accelerates so quickly during takeoff that time is compressed inside any pilot's ability to read a stack of CAS messages. I recently timed a fairly heavy GVII takeoff and found the "80 kt." call took place 15 sec. after brake release and V1 was just 7 sec. later. If your answer is "I'll abort for any red or amber CAS" you should carefully look at the possible messages your



FLIGHTSAFETY INTERNATIONAL

FlightSafety G500 flight training device

From a pilot's perspective, this airplane flies like an airplane.

By the time we showed up for our first simulator session, we already had a firm grasp on the cockpit screens, the systems and how to fly the airplane under normal conditions. We lightly delved into abnormal procedures and had already heard several times Norris' final cliché: "This is a fly-by-CAS airplane."

Philosophy Three

We pilots are paid the big bucks because of our superhuman abilities to make lightning-quick decisions under high stress. Yes, not many mortals can be shooting down a runway at over 100 mph, seconds before the ominously named "decision speed" and hear a triple chime; scan a list of red, amber and cyan crew alerting system (CAS) messages; and decide to abort or continue a takeoff. Yes, that's what we do. But that has become a lie because our jets have become so fast.

airplane can throw at you.

This isn't just a problem with the speed of our jets, it is also the very nature of the CAS as typically designed. You normally have red (that's the really bad stuff), amber (that's bad but not too bad), cyan (sometimes bad, sometimes good) and white (informational) CAS messages. These messages stack onto our displays in the order they occur, the first ones on the bottom. The only further delineation is by severity: red on top, followed by amber, cyan and white.

With the GVII, CAS messages can be grouped underneath one another by consequence. A causal CAS, such as an engine failure, will be an "umbrella" to others that are "consequential alerts." A right-engine failure, for example, has several consequences:

- R Eng Fail (U)**
- >R Hyd System Fail (U)**
- >L-R Outboard Brake Fail**
- >Spoiler Panel Fail (U)**

Note that the consequential alerts can also be umbrella messages themselves. You can quickly discern what the causes

are and what are just consequences to those causes. The alerting system further protects the pilot from distraction by filtering these messages in varying levels: low-speed takeoff, high-speed takeoff and landing. There is little a pilot can do about an engine fire at V_1 , for example. That message would be filtered starting at V_1-5 until 400 ft. above the runway or 30 sec. after takeoff.

The combination of the more intelligently stacked CAS messages and smarter filtering greatly reduces the burdens on pilot decision-making during critical phases of flight. The V_1 conundrum is now reduced to: "Double or triple chime before V_1 : Abort, otherwise continue the takeoff."

The Simulator

The first time I strapped into the pilot's seat of a GVII full flight simulator I felt instantly at home. The seat is comfortable, the sidestick armrest adjustable to the point there is no undue arm or wrist strain, and every touch screen and display is just where you want them. Beyond that, I was taken aback by the clarity of the simulator's visuals. The outside scenery is presented on curved mirrors that give the pilot unparalleled visibility forward and aft.

Our sim instructor was Brian Greene, another founding member of the Gulfstream/FlightSafety design build team. Just as it was with our classroom sessions, Greene seemed to discard the original simulator instructor's playbook. Starting with our first session we were encouraged to "see what she can do" and get comfortable with stick and rudder with a real stick. We had further "see what she can do" demonstrations in follow-on sessions to really understand the flight envelope protection designed into the airplane.

Unlike some initial flight courses, this one did not tailor the simulator sessions to teach for the check ride; there was no "check-ride profile" practice. Each session built on the previous lesson and we slowly, but surely, learned what we needed to know. The simulators are brand new and are, as they should be, in excellent condition. Greene never hesitated to put the world on "freeze" so he could point out whatever we had missed. Between my simulator partner and me, we had a collective 80 years of flight experience and nearly 30 of those in Gulfstreams. But as Norris reminded us often, this airplane is different and we had to forget our "first loves."



FLIGHTSAFETY INTERNATIONAL

FlightSafety G500 flight simulator

I have rarely experienced an aircraft initial course in which the simulator so effectively translated theory into practice. During one of our unusual attitude recovery exercises, my simulator partner put the airplane into a steep dive and by the time I was told to open my eyes and recover, we were well beyond VMO. I applied the correct nose-low recovery procedure only to find the nose well above the horizon and I had to execute a nose-high recovery. In a fit of embarrassment, I gave the novice pilot's complaint: "Why is it doing that?" Norris answered with his own question: "When does the high-speed protection mode of the flight control computer kick in?" Of course, the airplane was designed to protect us in that very situation.

It seemed hardly a day went by without Greene providing us an epiphany of one sort or another. In any other airplane I would have to wonder what I

was doing: I am far too experienced to be learning at such a level. It is as if I was saying to myself, "I'm better than this!" But this is a new airplane in many ways and after 22 days it would seem I learned enough. This was type rating No. 9 for me.

I sent FlightSafety International a five-page critique that was 90% praise with a little room left over begging for a better textbook than provided by iFlightDECK. The instructors are the best. Likewise, the classroom, the FTD and the simulator were the best I had ever experienced. I think any other training provider can learn from this program.

As we ready to take delivery, the training has increased my excitement at the prospect of flying with those touch screens, the magical sidestick and everything else on this airplane designed to make my life as a pilot easier. I had to shovel my way through a lot of complexity, to be sure. Now I truly appreciate the simplicity all of that effort gets me. These are philosophies I can learn to love. **BCA**

The author's new aircraft on its second flight



AC-U-KWIK

Your Global Resource for Vital
Business Aviation Information



2019-2020 Managers' World Edition
NOW AVAILABLE to order!

Plan. Schedule. Dispatch.

Order yours at Acukwik.com/products



AIR CULINAIRE WORLDWIDE

High-Altitude Haute Cuisine

Providing **fine dining aloft** isn't a trivial or inexpensive task

BY **FRED GEORGE** fred.george@informa.com

Years ago, Learjet Corp. produced a promotional film called “It’s All About Time” that emphasized the travel hours that could be saved by using a business aircraft, in large part because of its on-demand dispatch flexibility. Business jets afforded premium level transportation and commanded premium level prices.

Discerning passengers aboard such aircraft also expected premium level accommodations and cabin services, including food and beverage choices that were well above what commercial airlines delivered. Customer demand spawned the new specialty industry of on-demand inflight catering, companies that offered quick response, exceptional quality and plane-side delivery convenience. Premium level catering commanded premium level prices.

While clients might balk at the tab, it’s worth noting that such caterers’ costs can be considerably higher than many people realize.

“You want [déclassé] prices? Expect

[déclassé] quality. You want Ritz-Carlton or W Hotel quality? Expect premium prices,” says Paula Kraft, founding partner of the DaVinci Inflight Training Institute in Fort Lauderdale, Florida. “Just look at what it takes to maintain a minimal inflight catering kitchen. You need an executive chef, a sous-chef, a shopper and a driver. You have to be on call 24/7, so that if you get a 2:00 a.m. call, the order is ready for a 6:00 a.m. plane-side delivery.”

She should know. She founded Tastefully Yours Catering, a long-time, well-respected caterer based at Atlanta’s DeKalb-Peachtree Airport (KPDK) and regularly writes about catering for various publications. She’s also active in the International Caterers Association, the International Inflight Food Service Association and she is a board member of Women in Corporate Aviation, along with being the past chair of the NBAA’s Flight Attendant Advisory Committee.

“We’re in the service industry,” says Kraft. She notes that top-flight catering

demands all fresh ingredients, all homemade soups, sauces and stocks. Perishables, such as dairy products and eggs, milk, yogurt, butter, cheese and ice cream, all have short shelf lives, even at continuous 38F to 40F temperatures. Once the seal is broken on the container, dairy products start to absorb flavors from other foods in the refrigerator. Fresh meat and poultry age quickly in cold storage. They’re spoiled in minutes or less than an hour at room temperature. Most fruits and vegetables should be stored separately at 45F to 50F. Broccoli is an exception, as it needs colder storage.

Seafood lasts only a few hours, a few days at most, even when stored at an ideal 34F temperature. Live shellfish, such as crabs, lobsters and prawns, should be stored at 34F to 38F. The standard for freshness in business jet catering is the same as at three-star Michelin restaurants.

Kraft says Rudy’s Inflight Catering and Air Culinaire are two top-tier food

and beverage suppliers that provide good value for the dollar, even if their prices can be higher than those of some competitors. Air Gourmet and Silver Lining round out the top four inflight catering firms, says Susan Friedenber, founder of Corporate Flight Attendant Training & Consulting and former member of the NBAA Flight Attendant Advisory Committee.

While caterers attempt to stock a wide variety of menu items, costs for certain foods vary with seasonal availability. "Caterers only have what they have," says Friedenber. "They have to shop, pick up and deliver seasonal foods. The price of shrimp, for instance, varies widely with seasonal demand and supply."

Caterers, however, are adept at meeting customers' set price requirements. "We had [a fractional ownership operator] contract with us for crew meals: \$10 for breakfast, \$15 for lunch and \$20 for dinner," says Kraft. The firm preferred steak dinners for its crews and required an 8-oz. portion size. We did it! We found 8-oz., select-grade 'perfect' filets from a wholesale house." Many sports teams also order catering-to-cost, so most professional athletes get crew-quality meals, says Kraft.

Notably, select-grade beef seldom makes supermarkets that offer second-tier "choice" or top-line "prime" grade beef. It's mainly ordered by institutions and some fast-food franchises that use it for hamburger meat.

"For our corporate customers, we offer 8-oz. aged prime filets. And our wholesale cost is \$30 apiece," Kraft remarks.

"'Catering budget' is an oxymoron in corporate aviation," Friedenber quips.

Special Standards for Safety, Security and Sanitation

Food safety is a major focus for Friedenber. Food handling for aircraft is critical. The highest quality catering can make people sick — or worse, if safety links in the food-handling chain from farm to wholesaler to caterer to aircraft galley break down. On transoceanic flights, for instance, passengers may be hours away from suitable divert fields with nearby full-service medical centers. Food poisoning might be an unpleasant annoyance on the ground, but it has potentially far more dire consequences in the air. She always orders different meals, preferably from different caterers for crew and passengers. Even different salad dressings are a must.

She insists that each caterer provide credentials, including a local board of health "A" rating, HACCP (hazard analysis and critical control points) certification, FDA (Food and Drug Administration) certification and insurance bonding. She personally inspects many facilities to look for seamless floors that can't hide food-harboring bacteria and rigorous, frequent kitchen cleaning procedures.

Passengers may have special dietary requirements, food allergies and culinary preferences. Friedenber provides her clients with a nine-page questionnaire as a template, enabling them to work with passengers regarding gluten-free carbohydrates, peanut allergies and observation of religious dietary laws. Some passengers will eat fish or chicken, but not red meat. Others are vegetarians who also eat dairy products. And still others are strict vegans, limiting

aircraft galley." She insists that cooked items be heated to 170F and then immediately chilled to 40F for transport to the aircraft. Storage containers must be sanitized and sealed with polyethylene stretch wrap, then packed in alternating layers of ice and food in coolers. Reusable, long-life, frozen blue ice packs may be preferable, if allowed by the aircraft weight budget.

"You may repack catering at the flight kitchen with your own clean food boxes, pack it with dry and wet ice and then pack your own coolers," she says. Dry ice may be difficult to obtain at some locations. But Friedenber says business aircraft operators usually can buy it from airline flight kitchens at major commercial airports, given a prior request.

While dry ice is considered a hazardous material, it's OK to use it to keep catering cold, as long as storage containers are kept in the aft baggage compartment where carbon dioxide vapors will



If you want Ritz-Carlton or W Hotel quality, expect premium prices from your caterers.

STOCKPHOTO

diet choices to legumes, nuts, seeds and tofu, along with soy dairy-free products, seaweed and whole grains. Catering for vegans who have gluten or peanut allergies can be especially challenging.

Certain passengers also have favorite coffees, teas or other non-alcoholic beverages that may have to be procured outside of conventional catering providers. These items have a finite shelf life, but they may be considered "non-perishable" for extended, multi-leg business trips.

Friedenber notes that the highest sanitation and food handling standards provided by caterers can be negated by improper handling after the food leaves the gourmet kitchen. "Bacteria doubles every 20 min., if the food isn't kept cold and sealed from inflight kitchen to

be exhausted through the aircraft's air distribution system to the pressurization outflow valves rather than entering the passenger cabin.

"You can't blame a caterer for food poisoning if the crew doesn't handle the food properly," says Friedenber. Some of the biggest challenges are caused by passengers showing up hours late for departure. Most business jet galleys don't have adequate cooling or refrigerated storage before APU or engine start. So, food items may have to be stored in iced coolers in the baggage compartment for prolonged periods before they are moved to the galley just prior to passenger boarding.

Overseas trip layovers present special challenges. It may be difficult or

impossible to vet the credentials of local flight kitchens. Under such circumstances, Friedenberg says contacting Rudy's aviation services network and Air Culinaire Worldwide are two of the best alternatives.

Vetting flight caterers and personally overseeing food handling from kitchen to aircraft can be critical. Friedenberg recalls an incident during which a Saudi royal family member insisted on "no catering" during a layover in a neighboring Gulf State nation. Nonetheless, the FBO delivered food for both the flight crew and the passenger cabin. The Saudi family member wouldn't touch the unexpected catering, so the flight attendant took advantage of the "free lunch" after arriving at the destination. Within an hour, he became seriously ill and was rushed to the hospital. Soon,

more of a consideration for air charter operators, she says. But if quality slips and prices are high, customers ask tough questions that she alone must answer.

In the Seattle area, she has home-field advantage. She prefers to use local high-end restaurants that have catering departments, ones that she's personally vetted. She's also "groomed" select local executive chefs in the fine art of aircraft catering, showing them what her clients expect in food quality, presentation and taste.

"I work directly with the chefs, specifying in minute detail the portion sizes, garnishes, food appearance and food handling. I also listen and take notes on how to reheat foods, covered or uncovered, how long and at what oven temperatures. For example, should a hot

acts as the agent, then there are multiple risks of lapses in portion sizes, food selections, quality expectations and table presentation disappointments.

Fresh sushi is one of the most challenging passenger requests. "It's tough. You may need to ask chefs to show up hours before the restaurant opens to the public. Sushi needs to be kept cold from kitchen to galley. You need ice packs and your own coolers."

Overseas missions, especially to the Middle East and Africa, Mexico and Latin America, may pose greater challenges. "Try getting a Caesar salad in Nouakchott, Mauritania," she says.

But even if you're sure you can fill your wish list, "You always have to have a Plan B," says Walker. "We travel with large coolers filled with stock frozen foods and dry plus wet ice. We insulate food packages with cardboard spacers to prevent dry ice freezer burn." Dry ice sublimates into carbon dioxide at -109.3F, up to 100F colder than a conventional commercial freezer.

"If all else fails, we stock pesto sauce, we can get pasta at local hotels and we can thaw sliced turkey and bread from the freezer coolers. We carry eggs from home that we can scramble for breakfast."

Kraft, Friedenberg and Walker, among others, say that while quality catering is expensive, it's essential to control costs within reason. Most caterers won't publish prices with their menus because their costs float with the seasonal availability of produce, seafood and supplies. So, it's important to get price quotes for everything you order and refuse to sign for it without a complete cost breakdown.

"Twenty-five dollars apiece for three lemon crowns? C'mon, give me a break," says Friedenberg. "And \$22 for a quart of orange juice from [one Louisville caterer] but only \$12 for OJ from Rudy's? Why the markup?"

Friedenberg and Kraft also say to look closely at delivery, service, after-hours, airport access and other fees. Industry sources also tell *BCA* that some FBOs mark-up catering 15% to 20% when ordered through them. And some also charge caterers a ramp access fee for delivering directly to the aircraft.

High-ticket catering doesn't fit every business aircraft operator's budget. Flight departments proactively need to ask passengers what fills their bellies while fitting their budgets. If fine cuisine is expected, expect that to be reflected in the final tab. **BCA**

ISTOCKPHOTO



Flight attendants specialize in presentation skills — eye appeal, aroma allure and temperature perfection.

the stricken flight attendant was on life support in the trauma center's emergency room. He nearly died but then recovered albeit slowly. The cause? She said the food was laced with strychnine.

Advice From *Fortune* 50 Flight Attendant

Maureen Walker is founder of Seattle-based Walker Aviation, a firm that has provided contract flight attendant services, consulting and training for more than 25 years. Her clients include Boeing and many of the major flight departments in the Pacific Northwest.

Her main customer demographic doesn't mind high catering prices as long as the quality matches the bill. It's

dish be heated for 5 min. at 425F or 15 min. at 350F," says Walker.

She says her first choice at home is to work with local restaurants because they may offer unusual dishes not available through commercial inflight caterers. Away from Seattle, she communicates with a network of business aircraft flight attendants to get recommendations for local high-end caterers at distant stopovers. Walker cites Stevie's Aviation Catering at Van Nuys Airport and Chefs with Altitude (now closed) in Los Angeles as two examples.

Her third choices are recommendations from FBOs. But she insists on working directly with the catering company, preferably with the executive chef to eliminate communication errors. If the FBO

AirCharter

GUIDE

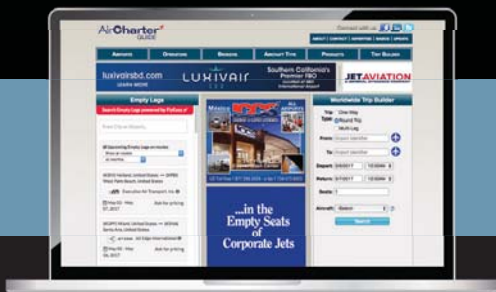

Know Your Options

So many destinations.
So many aircraft.
One source: aircharterguide.com.

Voila, Le Bourget

More than a century old, the storied Parisian airport is now **Europe's premier business aviation facility**



BY **DAVID ESLER** david.esler@comcast.net

Think of Parisian artifacts that have become iconic to the City of Lights. The Eiffel Tower. The now fire-damaged Notre Dame Cathedral. The Louvre Museum. Sacre-Coeur Basilica. The Arc de Triomphe. Le Bourget Airport.

Excusez-moi. Un aeroport?

Oui, messieurs et mesdames. Paris' original airdrome bears the distinction of being the most famous airport in France and one of the 10 oldest in the world. Founded during World War I near the commune of Le Bourget as the principal base of operations for the Aeronautique Militaire, precursor of the French Air Force, it was converted to civil operations after the Armistice that ended the Great War. In 1919, now named Aeroport de Paris-Le Bourget, it hosted the first commercial air service in France, with flights between Paris and Brussels, as well as Paris and London, and remained Paris' sole airport until Orly International was commissioned in 1932.

To most of the world, however, Le Bourget is famous as the place where Charles Lindbergh landed his Spirit of

St. Louis in 1927, completing the first successful nonstop solo transatlantic flight. Today, a plaque set in the concrete of Le Bourget's ramp marks the spot where the Lone Eagle's single-engine Ryan monoplane touched down after a 33.5-hr. flight from Roosevelt Field on Long Island, New York.

Less known outside of France was the attempt to cross the Atlantic by French World War I heroes Charles Nungesser and Francois Coli in the biplane L'Oiseau Blanc (the White Bird). Taking off from Le Bourget two weeks before Lindbergh departed on his attempt, after passing over Ireland, the aircraft was never seen again. There's still belief that L'Oiseau Blanc actually reached North America and crashed somewhere in Newfoundland or in the heavily forested interior of Maine, but no remains of the aircraft have ever been found. Three years later, Le Bourget again became the departure point for a transatlantic attempt, this time for the first successful westbound Atlantic crossing by Dieudonne Costes and Maurice Bellonte, who steered their Breguet XIX Point d'Interrogation across the waves to New York.

Now more than 100 years old, Aeroport de Paris-Le Bourget is Europe's only dedicated business aviation airport – except when it's the site for the biennial Paris Airshow. Then it hosts some of the largest aircraft in the world.

CITIZEN9/WIKIMEDIA

In conjunction with the Paris World Fair in 1937, a new airline terminal was constructed at Le Bourget, designed by architect Georges Labro. But after France was overrun by Nazi Germany in 1940, the airport once again became a military field, this time as the headquarters for the Luftwaffe in France. That year also saw Adolph Hitler land at Le Bourget in a Junkers trimotor for his only tour of occupied Paris. The Germans embarked on an improvement plan for the airport, constructing concrete runways that served as convenient targets for several Allied bombings of the field during World War II.

After the 1944 liberation of Paris, Le Bourget was quickly restored for airline service, and in May 1945, it became the repatriation conduit for 42,000 former prisoners of war. Through the late 1940s, air traffic increased rapidly, prompting Paris to adopt Orly as its main commercial airport in 1952, with Le Bourget

designated as a reliever and hub for domestic flights. The following year, now assigned the ICAO designator LFPB, the field became the site for the first Salon International de l'Aeronautique et de l'Espace, *i.e.*, the Paris Airshow — the largest aviation exposition in the world — which it has remained every other year since, alternating with the U.K.'s Farnborough Airshow Today, it is also the location of the Musee de l'Air et de l'Espace, the oldest aviation museum on the planet.

Dedicated to Business Aviation

By the early 1970s, traffic had increased to the point where both Orly (LFPO) and Le Bourget had reached capacity, and the decision was made to build another airport at Roissy-en-France, on the north side of Paris. Named Charles de Gaulle International Airport (CDG), the new field was inaugurated in 1973 and today rules as the dominant Parisian airport with multiple terminals and plenty of room to grow. So much so, in fact, that in 1977, airline service was terminated at Le Bourget, and the field was converted yet again, this time to a general aviation airport principally serving business aviation.

When business goes to the European continent, it most often goes to Paris, and over the years since airline service at Le Bourget was redirected to CDG and Orly, LFPB has far outpaced any other European business aviation destination by movements. And assuming the U.K.'s Brexit initiative — its departure from the EU — kicks in, and some financial institutions move to the European mainland, especially to Paris, international business aviation traffic at Le Bourget would likely increase even further.

While LFPB is technically a general aviation airport, light piston aircraft are pretty much shut out by a VFR operations prohibition there, thus limiting the field almost exclusively to turbine-powered business aircraft. As such, Le Bourget may classify as the only airport in the world so designated. (Light aircraft can access several small VFR general aviation airports that ring Paris.) So, given the role it plays in accepting all the business aviation flying into Paris, its movement numbers and its support base, it could be said that Le Bourget is the “Teterboro of Europe.”

According to the European Business Aviation Association (EBAA), in 2018, Le Bourget chalked up 53,686 total business aviation movements: 26,952

departures and 26,734 arrivals, 4.9% more than the previous year and ranking it No. 1 in Europe in terms of business aviation operations. No. 2 was also a French airport, Nice Cote d'Azur (LFMN), with 35,449 movements. No. 3 was Switzerland's Geneva International (LSGG) with 33,569 movements, and No. 4 and No. 5 were the U.K.'s Luton (EGGW) and Farnborough (EGLF) with, respectively, 28,002 and 27,916 movements.

At Le Bourget, again in 2018, light jets accounted for 20,088 of the movements and heavy jets like Gulfstreams, Globals and the bigger Falcons accounted for 18,328 movements. Midsize jets tallied 7,716 movements, turboprops numbered 6,403, and what the EBAA terms “bizliners” were responsible for 1,151. In terms of types, the Cessna Citation Excel/XLS led the parade with 3,704 movements, followed by the Citation Mustang (3,675), the Dassault Falcon 2000 (3,168), Bombardier Global Express (3,137) and Pilatus PC-12 (3,000).

Le Bourget is owned and operated by the public/private consortium Groupe ADP, 50.6% of which is possessed by the French government. Altogether, ADP — whose headquarters is located at Le Bourget — owns 10 French airdromes, including Charles de Gaulle and Orly, and has stakes in others around the world. But the privatization bug has bit hard in France and privatizing ADP and selling off the French stock of airports is a key part of President Emmanuel Macron's master plan for reducing France's debt. In March, the French Parliament voted to approve a law governing the privatization plan, and the following month the National Assembly voted to privatize ADP. How this will ultimately play out and what its effect may have on Le Bourget remains to be seen.

Meanwhile, LFPB continues to service the business aviation community as a dedicated base of operations equipped

Dassault Falcon Service Deputy General Manager Thierry Salaun shows off the MRO facility's repair station certifications from 39 countries. The Le Bourget operation's territory is the entire Eastern Hemisphere, and 400 Falcon business jets pass through its multiple hangers annually.

with seven FBOs on the field: Advanced Air Support International, Dassault Falcon Service, Euralair Airport Services, Jetex Flight Support, Signature Flight Support, Sky Valet and Universal Aviation. With all those FBOs competing for operators' business, fuel is readily available from multiple refiners and vendors. MRO (maintenance, repair and overhaul) services are also provided by Air France Industries/KLM Engineering & Maintenance, a Cessna Citation Service Center, Dassault Falcon Service for the Falcon product line, and Universal Jet for Gulfstream types. And FlightSafety International, one of the oldest tenants on the airport, operates a training center for various Falcon Jet and Embraer aircraft types and, soon, the Pilatus PC-24.

A Long Relationship

Both FlightSafety and Dassault have had a long relationship in France, the FlightSafety center at Le Bourget having been originally established as a joint venture with Dassault. According to center manager Yannick Kerriou, when the airframer launched the Mystere 20 — later renamed Falcon 20 — in 1966, FlightSafety struck a deal with Dassault to provide pilot training for the aircraft. Originally located at Velizy, south of Paris, the operation was backed 50% by FlightSafety and christened the Falcon Training Centre. In 1986, the operation was moved to Le Bourget. Beginning with the Falcon 20, the operation soon expanded to include the Falcon 10 and then the Falcon 50, 900 and 2000, as the Dassault product line expanded.



DAVID ESLEY/BCA

Le Bourget's Driven Denizen

An enthusiastic bundle of energy in his seventh decade, Alexandre Couvelaire is inextricably connected with the elevation of Le Bourget into Europe's premier business aviation airport.

In 1961, Couvelaire founded his first aviation business, Societe d'Etudes de Recherches et de Ventes a l'Interieur de la Communaute Europeenne, or SERVICE, at Toussus-le-Noble Airport, the first aircraft management company in France — and possibly Europe. Three years later, the operation was moved into a new hangar on the north side of Le Bourget Airport, becoming the first operator there to field business aircraft, a motley collection of single- and twin-engine types.

In 1966, he and his partners spun off a subsidiary to sell unused hours on its pool of aircraft to third parties, and Euralair was born. Two years later, the company moved into the ranks of turbine-powered aircraft operators with Learjets operated under multi-owner arrangements.

With Euralair growing rapidly, a pair of managed Fokker F-27 turboprops was added to the fleet in 1968 and, four years later, replaced by two Sud Aviation Caravelle jets that Euralair operated with two-pilot crews, inciting the ire of French pilot unions that insisted the aircraft be flown with a third pilot in each cockpit to help manage systems. By the late 1970s, the company was one of the largest commercial operators in France, providing on-demand flights with a fleet of five Boeing 737-200s.

A contract to operate the old Caravelles on behalf of Air France was extended to the Boeing fleet, resulting in Air France pilots going on strike, demanding that the “cooperation agreement” forged previously to accommodate the two-pilot Sud transports be

terminated. Eventually, Euralair was banned from conducting commercial air transport in France for three years. Couvelaire subsequently leased three of the 737s to Air France's charter subsidiary, sans pilots.

Of significance to business aviation, Euralair purchased Mooney Aircraft in 1984, its first foray into manufacturing. Then Couvelaire linked the industries of the U.S. and France through a pact with Socata to develop the TBM 700 single-engine turboprop (its letter “M” stands for Mooney). Meanwhile, Euralair's charter/management fleet at Le Bourget was being populated with the newest products from Dassault and Cessna, and the airline was operating the latest B737 series, having been the launch customer for the -500, out of Paris Orly, airline service having been curtailed at LFPB in 1977. In 1999, Euralair became the first French carrier to operate the B737-800.

The same year, the company launched Euralair Airport Services, a dedicated business aviation ground handling enterprise, at Le Bourget. In the 21st century, Euralair continued to expand through partnerships in Europe and Africa, while the ground support operation at LFPB captured a 20% market share of fuel sales.

Meanwhile, Couvelaire has branched out into electric aviation by forging a partnership with Bye Aviation of Colorado, which is deep in development of a new battery-powered primary training aircraft. The peripatetic Frenchman sees electric power as the future of the industry and an ideal medium for pilot training — and investment — and at this stage of his life, he's just getting started. **BCA**



DAVID ESLEY/BCA

Thierry Salaun, deputy general manager of the Le Bourget-based Dassault Falcon Service MRO facility, which also includes an executive-level FBO and a charter operation.

It now embraces the current production line: The Falcon 2000EX EASy and LXS, 900EX EASy, 7X and 8X. Falcon 10 and 20 training is still offered and also includes the Coast Guard F20 variant, the Guardian, powered by the Honeywell ATF3 engine, as well as the Falcon 20-5 retrofitted with the Honeywell TFE731-5 turbofan and Collins Pro Line 4 avionics.

Some 70% of the center's activity is dedicated to Dassault products, with the remaining 30% supporting Embraer, including simulator training for the EMB120 turboprop, the ERJ145, the Legacy 650, and the E-Jet E1 and E2 for European, Middle Eastern and African customers in both business jets and airliners.

On a weekly basis, between 70 and 90 clients train at the Le Bourget center. It operates 14 simulators and will receive one more for the Pilatus jet in January with space remaining in the building for two more devices. Today, the center's flagship simulator is the Falcon 8X, the only one in the world. A vertically integrated operation, FlightSafety builds its own simulators near Tulsa, Oklahoma, with visual systems produced out of Austin, Texas, and St. Louis.

Why the Le Bourget location? *BCA* posed the question to Kerriou at a center visit during the Paris Airshow in June. “Historically,” he answered, “it is the busiest business aviation airport in Europe. With the training center there, we have proximity to the Dassault Falcon Service MRO station, making it a one-stop shop for the client — they can train and maintain in the same place at the same time, and many of them do that.

“We also have the proximity of

DAVID ESLEY/BCA



Alexandre Couvelaire, founder of Euralair, father of the TBM 700, and now a partner in electric aircraft developer Bye Aviation holds forth in a Paris cafe.

Aviation Week Continues the Urban Air Mobility Series – Seize the Opportunity and Join the Conversation!

AVIATION WEEK
UAM
ASIA-PACIFIC

September 25, 2019
Singapore
Register at
uamap.aviationweek.com

AVIATION WEEK
UAM
EUROPE

October 16, 2019
London, UK
Register at
uameurope.aviationweek.com

Hot Topics on the Agenda!

Industry Scorecard: Key Challenges for UAM in the Urban Environment

Kicking things off with an ecosystem level assessment of the substantive challenges that must be addressed to get to UAM operations. This session will take an overall, integrated look at the necessary benchmarks for implementation and a fully-realized UAM ecosystem.

Dr. James Wang, Professor and Director of eVTOL Research and Innovation Center, Nanyang Technological University (NTU)

Market Forecast

Hear the current status and trends that experts are seeing in the emerging Urban Air Mobility market. What are the enablers moving this market forward and why is it happening now? This session will lay-out a realistic timeline for what the market will look like 5, 10, and 15 years in the future.

The Race Is On: eVTOL Vehicles Take Flight

The world's leading eVTOL flying car and flying taxi manufacturers reveal their unique plans and current vehicle status for the future of flight. With Ehang and Volocopter.

Neo Kok Beng, Founder & CEO, NEO Aeronautics

Peter Littau, Head of Strategic Expansion, Volocopter

Battery Power & Propulsion Technologies

Hybrid electric propulsion systems and all electric technologies are enabling the emergence of eVTOL vehicles and a new era in aviation. Our panel of industry experts provide an overview of the progress, power and reliability of distributed electric propulsion system designs and what the future holds.

Transforming Mobility: Safety, Regulation, and Certification

The Asia-Pacific region has established itself as a pioneer when it comes to regulatory acceptance and encouragement of urban flight tests for eVTOL vehicles. This session will dive into the regulatory path to market for the region, including potential challenges ahead and opportunities for collaboration between industry and government.

Damian Cheng, Project Manager, Crimson S8, NEO Aeronautics

From the Ground Up: UAM Infrastructure Planning and Development

As we try to navigate and understand a new urban environment and the evolving and ever-present role of smart city applications, we discuss what strategies, testing and validation needs to be undertaken to get the buy-in of local officials, airports, businesses, developers and urban planners.

Conference will conclude with a

Networking Reception

Aviation Week's UAM series brings together manufacturers, regulators, technology innovators, disruptors, municipal leaders, and the infrastructure & investment community; all working together to create on-demand aviation for smart cities and a new future for manned and unmanned air transportation.

Hot Topics on the Agenda!

Industry Forecast

In this scene-setting session, engage holistically with the UAM ecosystem, consider the timeline and expectations for this market and what might impact it. What are the key trends and opportunities for stakeholders? As the UAM market continues to evolve, what individuals and organizations will be involved and what can they expect?

Manfred Hader, Senior Partner, Roland Berger

Infrastructure and Investment Panel Discussion

Attend this discussion to assess the infrastructure requirements: What collaboration has there been that is driving/facilitating progress and what further support is needed?

Ilya Khanykov, CEO, Bartini Inc. and Executive Advisor, McFly Aero Infrastructure

Understanding the Airbus Strategy

Harini Kalatunga, Head of UK UAM, Airbus

Regulatory and Certification: Critical Challenges

How can existing barriers be overcome and what regulators are working on making this happen? When we have progressed beyond initial test flights, how do we go about building and beginning to certify electric VTOLs?

David Tait, Innovation Strategy Lead, CAA

Antonios Tsourdos, Director of Research, School of Aerospace, Transport and Manufacturing, Head of the Centre for Autonomous and Cyber-Physical Systems, Cranfield University

Who are the Players in the Game?

Airframers Panel Discussion

Hear the airframers perspective on the outlook for UAM vehicles and how they will differentiate themselves in the market. What are the anticipated integration challenges?

Moderator: Robert Thomson, Partner, Roland Berger Strategy Associates

Harini Kalatunga, Head of UK UAM, Airbus

Deliveries and the Operating Environment

What is the operational environment of the future when we reach mass deployment? What capacity of deliveries of eVTOLs do we expect to see in the next 5, 10 and 20 years? How do we expect the vehicles to integrate with the other modes of urban transport and avoid conflicts and congestion?

Moderator: Sameer Savani, Head of Innovation and Engineering, ADS Group

Reaching Commencement of Operations: What Challenges Must be Overcome?

Considering passenger and public perception: What are the FAQs? Can media support enhance social acceptance? How will eVTOL work around traditional airlines, airports and other competition?

Yann Cambier, Senior Manager, ICF

Rui Roosien, Consultant, Netherlands Research Center

Conference will conclude with a

Networking Reception

Dassault itself,” he continued, “and so can support the sales of its products with demos in the simulators.” FlightSafety also provides maintenance training, both airframe and avionics (B1 for airframe and B2 for electrics and avionics, in European Aviation Safety Agency nomenclature). “So, we are training techs for all Dassault and Embraer types. And with the history here taking us back to the '60s, it is an iconic place. Also, the field is convenient to Charles de Gaulle International Airport and airline pilots operating Embraer equipment.”

In the early 2000s, a recession in the economics of Le Bourget resulted when Aerospatiale and Air France maintenance facilities were moved off the field. “There was a drive from ADP to reenergize the airport,” Kerriou said. “New airframes like the Falcon 2000 brought in more business. For us, it translated into expansion with the addition of three more simulator bays.” Production of new airframes by Dassault included the Falcon 2000LXS in 2016 and the Falcon 8X in 2018, both resulting in additional simulators at the Le Bourget center, bolstered by the Embraer E-Jet E2 this year. “We see a strong future for the airport and FSI here,” Kerriou said, “we see our footprint expanding.”

Just down the Avenue de l'Europe from FlightSafety is the Dassault Falcon Service FBO and maintenance base. “The Le Bourget operation is the major service center for Falcon in the world,” said Thierry Salaun, deputy general manager of the facility. The repair station has 30 maintenance slots dedicated to Falcons, logs approximately 500,000 person-hours of work annually, and employs 650 people including a charter operation.

“We are in charge of the Eastern Hemisphere,” Salaun said, “or everything other than what is handled by Dassault Aircraft Services in North America. We've taken over TAG in Geneva and ExecuJet worldwide, and this expands the network.” Every year approximately 400 aircraft pass through the center for heavy maintenance, while ramp service at the FBO, which in May was awarded an IS-BAH (International Standard for Business Aircraft Handling) Stage 1 certification, handles 4,000 actions. Over a three-year period, the center sees the whole Falcon fleet in its area of responsibility, or about 800 aircraft. “We are doing well with MRO,” Salaun claimed. “The hangars are full.” The operation holds 39 repair station certifications from countries where Falcons are registered and whose operators bring them to the facility for

service. Meanwhile, the Falcon Response charter service fields six dedicated aircraft, including Falcon 900, 7X and 8X types, logging approximately 2,000 hr./year of flying.

All Business Aviation All the Time

Le Bourget is a 24-hr. airport with no slot control. While it is dedicated to business aviation, which characteristically involves aircraft weighing less than 100,000 lb. MTOW, Le Bourget officials point out that the airport can accommodate just about any aircraft, as the Paris Air Show proves every 24 months. As an example, in 1989, the Russians brought the Antonov An-225 Mriya — at 1.4 million lb. (640,000 kg.) MTOW, the largest air transport ever built — to the show with the Soviet space shuttle Buran mounted atop the fuselage.

The airport has three runways:

- ▶ Runway 3/21, 8,743 ft. long by 197 ft. wide, asphalt, PCN: 047FCWU.
- ▶ Runway 7/25, 9,843 ft. long by 148 ft. wide, concrete (middle 5,774 ft. grooved), PCN: 058RCWU.
- ▶ Runway 9/27, 6,053 ft. long by 148 ft. wide, asphalt, PCN: 035FCWT.

Field elevation is 218 ft. (66 meters). Nav aids include ILSes for Runways 7/25 and 9/27 and a VOR-DME located on the field. Approach and departure control for Le Bourget is handled by Charles de Gaulle Airport, whose controlled airspace overlays the smaller facility. Several hotels are located nearby, and as the

French crow flies, the airport sits 4.3 sm (7 km) north-northeast of Paris Center — but much farther by road distance. Traffic in the city tends to be abysmal, especially during rush hours, so if principals are staying downtown, plan limo or taxi rides accordingly. (Parisian taxi drivers are the recognized experts in knowing how to navigate the congestion and avoid bottlenecks. They are simply amazing — but be prepared for some white-knuckle rides. Crews should add at least 90 min. to get to Le Bourget from downtown in their preflight preparation times.

Business aviation pilots we queried were universally positive about recent forays into Le Bourget and subsequent ground handling at the airport's multiple FBOs. (Competition works.) Flight crews approaching Le Bourget should be constantly aware, however, that they are entering some of the most congested airspace in Europe. Gulfstream 650 captain Nat Iyengar, who often operates into that airspace, reminded readers that Le Bourget is “literally next door” to Charles de Gaulle and its four busy runways. “It is vitally important the crew is very aware of the CDG airport proximity and the ‘do not overfly’ zone to the south of the CDG south runway complex,” he cautioned. He added that the Runway 7 missed approach requires “good crew situational awareness.”

When inbound, Charles de Gaulle Radar is the initial approach control. Landing to the east, expect ILS Runway 7. “You



Yannick Kerriou, manager of FlightSafety International's Le Bourget Falcon Training Center, with one of his instructors in a Falcon 8X procedures trainer. FSI has operated the center in partnership with Dassault Aviation since the Falcon 20 business jet was conceived in 1966.

DAVID ESER/BCA



FlightSafety International Le Bourget Falcon Training Center Manager Yannick Kerriou with one of the facility's Falcon Jet simulators. The center contains 14 full-motion simulators covering the full Falcon product line plus Embraer airliner types and will introduce the Pilatus PC-24 sim in January.

can request the RNAV [GNSS] Runway 7, if preferred," Iyengar noted. "General procedure is vectors to final." Landing to the west, Runway 27 is preferred, again normally using the ILS approach and with the RNAV approach on request.

The arrivals are straightforward, Iyengar claimed. "We guessed at the appropriate arrival based on the fixes on our flight plan and the runway in use." Coming from over England or from across the Atlantic aircraft will normally receive the PEXIR and VELOL 7E RNAV STAR (i.e., Runway 7 RNAV arrivals) or the PEXIR and VELOL 7W RNAV STAR (i.e., Runways 25 and 27 RNAV arrivals).

And one item of caution: "It is easy to be distracted when operating in the Le Bourget area as you get a great view of Paris," Iyengar pointed out. "So, it's not difficult to have all eyes in the cockpit sightseeing."

Flight crews new to Le Bourget or returning after a long absence are urged to consult the French State Rules and Procedures as part of their preflight planning. "There is information that should be reviewed here, such as radio phraseology, reduced reporting procedures," Iyengar said. "It is important to use standard ICAO phraseology and stay away from U.S. ATC slang. I often hear U.S. crews using common U.S. ATC phraseology, and it confuses foreign ATC." A common example of this, Iyengar cited, is saying "oh" in lieu of "zero."

One other piece of advice from the G650 captain is to "be sure to coordinate with your handling agent as to exactly where they want you to go. For example, Signature has two terminals, and they are not next door to each other. Ground will inquire as to your parking destination."

And he offers more warnings on Paris surface traffic: "Traffic to Paris city center can be horrendous. If you are from NYC or SFO you will be used to it. The drive from Le Bourget to [a downtown hotel] can take anywhere between 45 min. and 2 hr., 45 min. Throw in some rain, and all bets are off." Passengers must be

prepared and briefed in advance for the departure from Paris, as there will be a slot time to which the flight must adhere — in this case, not an LFPG takeoff slot, as the airport does not assign slots, but a Eurocontrol en route slot.

Steve Thorpe, a senior Gulfstream captain for a major pharmaceutical company, who also files to Le Bourget frequently, added that, "once within about 200 nm of the airport, the flight crew should start inquiring as to the arrival to be expected by ATC. If you don't, they will either assume you know — bad idea — or will issue the arrival right before the initial arrival fix."

In Europe, the landing procedure is often divided into three phases: the arrival, a transition to the approach and the approach itself. So, load the procedure backward on the FMS, Thorpe advises, starting with the runway, then the approach, the transition and the arrival. "So, if you wait until the last minute, you can see where you may fly off the end of your 'magenta line' while programming the whole kit and caboodle. And, be ready for changes. Approach control has been known to change things up at the last minute, or in the middle of one arrival, switching to another."

And on the ground, Thorpe advised, "If you are a [FAR] Part 91 flight, be sure the 'private' box is checked on the fuel slip. Customs at Le Bourget will come to check and violate the crew if it is a private flight and, even by mistake or lack of oversight, the 'commercial' box is checked."

Surviving a SAFA Check

Then there is the dreaded SAFA (Safety Assessment of Foreign Aircraft) ramp check that has apparently taken on a reputation in France (even though it is enforced throughout Europe) far more nefarious than its reality. A current issue, according to Thorpe, impinges on fuel reserves. "Per ICAO Annex 6, Part II, you need at least 5% contingency fuel: fuel for the full destination, which includes

a missed approach, SID and likely STAR to the alternate, 30 min. final reserve, and any discretionary reserve. They are wanting to see a column for each of these on your master document/computerized flight plan."

Further, added Gary Dietz, chief pilot for a major telecommunications company, "The French are simply going by the book — the ICAO Annexes. I respect their initiatives; it made us refine our flight planning process; it made us better." Know the handler's notes, Dietz recommends. Ask questions concerning APU starts (as some European locations place limits on how long an APU can be operated due to the fumes expelled onto the ramp) and customs. And most important, "Be prepared to show all your required documents: pilot and medical certificates, aircraft registration, and so forth." And, if necessary, remind SAFA inspectors that, if it's a Part 91 operation, there is no maximum age requirement for pilots.

Iyengar pointed out that "U.S. operators forget that the FAA has the greatest number of differences from ICAO standards and procedures," hence the focus on compliance with them. His advice for surviving a possible SAFA check is "to be organized in advance, and it will go well. The inspectors I have dealt with have always been courteous and appreciative of good organization and preparedness. There are many rumors about how many business jets get SAFA checked in Paris and the issues they have had. As Laurent Chapeau, head of the DGAC's Ramp Inspection Office, stated at the 2019 NBAA International Operators Conference, "There are very few."

In his shop, Dietz always uses a handling agency, and relies on its agent at the destination to interact with local authorities. "Most importantly, be respectful," he advised. "They [the inspectors and authorities] are simply performing their duties and responsibilities."

Dietz also made an argument for boning up on Le Bourget as part of preflight planning. "Prior to leaving your departure airport for LFPB, review the General Notes in Jeppesen for the airport. I will make note of certain expectations — speed limits, engine starts, and so forth — and make this part of the trip briefing and definitely the arrival briefing prior to descent. The more you know, the better the show." **BCA**

Urban Upheaval

The revolution could arrive **sooner than expected**



NASA

BY **PATRICK VEILLETTE** jumpraway@aol.com

Are we on the cusp of a total disruption in urban transportation? Skeptics, myself included, have long been involved in the negatives of helicopter operations in metropolitan settings including their noise, concern over air traffic management and the safety risk to those involved as well as bystanders, and, as always, the costs associated with vertical flight.

With the forgoing in mind, the speech of FAA Acting Administrator Dan Elwell at the Uber Elevate Summit in Washington, D.C., on June 12 was thought provoking, to say the least. “It is awesome to be here, soaking up the energy, creativity and innovation of a brand-new form of transportation. I find your vision of the future to be refreshing, invigorating even, and that’s not easy to say. We at the FAA have historically been a bit reticent to welcome new entrants into the national airspace system, but that is changing rapidly. It has to change because this kind of energy, innovation and vision is what will fuel the future of aerospace,” he said, adding, “Let’s face it, you make aerospace cool again.”

Considering his politically sensitive, high-visibility position, was he merely being polite to a vested audience, or do his words presage developments that will transpire and do so much more rapidly than many might have believed?

Proponents envision a network of compact, electric aircraft that take off and land vertically (eVTOL) to facilitate rapid, reliable transport between suburbs and cities, and, ultimately, within the city limits themselves. Such vehicles, which fall under a broader category of urban air mobility (UAM) aircraft, are expected to be a magnitude quieter, safer, more affordable and environmentally friendly than helicopters operating today. Their advocates believe that in the long term, such aircraft will be an affordable form of daily transportation for the masses, and some believe even less expensive than owning a car.

The irony of Elwell’s speech and the conference itself is that they took place in Washington, D.C., which enacted the “Helicopter Landing Pad Public Nuisance Act of 1987” prohibiting the operation of any helipad not in existence prior to July 14, 1987, in the nation’s capital.

NASA Aeronautics Mission Directorate (ARMD) Urban Air Mobility Grand Challenge Industry Day

The act is still in effect, and many cities have similar statutes inhibiting the establishment of any future helipads.

Technical, regulatory, environmental, economic and social barriers are among the many significant hurdles eVTOL aircraft must clear and they are discussed in-depth in “Fast Forwarding to a Future of On-Demand Urban Air Transportation,” which Uber Elevate published in October 2016. To succeed, eVTOL manufacturers will have to earn certification for air vehicles that have never existed and employ technologies that the FAA has never before seen, let alone evaluated and endorsed.

There are promising initiatives underway in new, more accommodating air traffic management systems, but their pace of development may ultimately slow segment growth. That’s a concern because the eVTOL/UAM economics depend upon scale — you need a lot of them to make them affordable. But then again, cities today don’t have

the infrastructure to accommodate such fleets.

While electrical propulsion offers immense potential, the present level of performance from batteries needs to undergo a quantum improvement.

The June 10 crash of a helicopter onto the roof of a high-rise office building in New York City alarmed emergency workers and citizens too familiar with airborne disaster. And even though the pilot, apparently disoriented by low visibility conditions, was the sole fatality, the incident once again brought to the fore the potential hazards of rotorcraft operating over densely populated areas. Will eVTOL/UAM aircraft achieve standards of safety that would calm community critics? That and the matter of noise leave no room for compromise.

In his speech, Elwell provided a potent example of how small drones are already changing the landscape of our economy, community and society. The Chula Vista Police Department in Southern California and Cape Aerial Telepresence, a private unmanned aircraft system (UAS) — aka, drones — company based in Redwood City, California, use drones to provide aerial views for officers to document accidents or crime scenes, and search for missing persons. In the previous eight months, they had launched drones on more than 500 calls in which 67 arrests resulted. In half sorties, the drones were first on scene with an average response rate of 96 sec. Equally important is that in 75 responses, a surface policeman wasn't needed at all.

They're hardly alone. Recently *Aviation Week & Space Technology* reported the Washington State Patrol now has a fleet of 111 quadcopters, possibly the largest drone fleet operated by a state or local law enforcement agency in the U.S., which troopers and detectives store in the trunks of their patrol vehicles. And a May 2018 study by the Center for the Study of the Drone at Bard College counted 599 law enforcement agencies that had acquired drones.

When the acting FAA administrator tells an audience, "I have a strong hunch that the benefits we discover with UAM [aircraft] will be no less extraordinary," that is a strong indication of his projection for the segment's potential. And others echo that sentiment.

NASA's Aeronautics Research Mission Directorate funded two UAM market studies that included several UAM segments, specifically air taxi/metro models, air ambulance and last-mile

package delivery. Those markets were found to have viable and profitable use case. The studies predicted that by 2030 there could be 750 million annual passenger trips in 15 metro areas and that by 2030 the "last-mile package delivery" market could be profitable and result in 500 million deliveries annually.

Aerospace corporate giants are wholeheartedly embracing the UAM concept and potential. Boeing's NeXT program is working on autonomous flight and advanced propulsion concepts to create the future transportation modes in urban, regional and global mobility. On Jan. 22, 2019, the company's autonomous passenger air vehicle completed its first flight. In November 2018, Boeing and SparkCognition formed a joint venture called SkyGrid to develop artificial intelligence (AI)-enabled dynamic traffic routing, data analytics and cybersecurity to safely perform a broad range of missions including package delivery, industrial inspections and emergency assistance.

At the 2018 Farnborough Air Show, Rolls-Royce and Aston Martin announced a plan to develop UAM vehicles. In addition, Airbus formed a new business unit in May 2018 with such activities in mind, and the Japanese government announced plans to invest \$40 million to accelerate UAMs.

Meanwhile, Uber, the ride hailing company, is developing shared air transportation between suburbs and cities, and ultimately within cities, planned for 2023. The company and its partners are working to launch fleets of eVTOL aircraft in Dallas, Los Angeles and a to-be-announced international location. Its partners include Boeing subsidiary Aurora Flight Sciences, Bell, EmbraerX, Karem Aircraft and Pipistrel Vertical Solutions, all with extensive expertise in aircraft manufacturing. It is also working with the U.S. Army's Research Laboratory to analyze and design stacked co-rotating propellers.

In addition, university programs that excel in rotorcraft aerodynamics

Not in My Backyard

Uber's early experience with "on-demand" aviation transport ended abruptly within 30 hr. of its launch offering of on-demand helicopter shuttle service from Salt Lake City to Park City at the beginning of the Sundance Film Festival. Even though the pilots adhered to "Fly Quiet" guidelines, the atmospheric conditions were conducive to propagating the helicopter noise made worse by the surrounding high terrain.

We had a "front row seat" to this show as the primary landing pad was just a mile from our back porch. Even though I am commercially rated in helicopters and often enjoy their sound, as soon as I heard the first beats of the rotor blades, I knew that the local residents were going to howl in protest. And they did! By morning of the second day the sheriff had deputies standing by to arrest the next pilot who attempted to land or take off.

There were many other problems to this deployment. The two helipads were woefully deficient in many of the aspects spelled out in the FAA Advisory Circular 150/5390-2B, "Helipad Design." For starters, the surface was inadequately prepared so that when the first helicopter attempted to land on the secondary pad, an immediate white-out was created by the rotor wash. It also didn't endear the helicopter operators when their approaches flew low over a favorite winter recreation site and wildlife preserve.

As a result, the county enacted new ordinances banning all but public safety helicopters from landing in areas adjacent to Park City, even to include the luxurious \$1 million plus homes in the nearby gated communities where helicopter transportation has sometimes been discussed to expedite private travel.

Communities tend to tolerate public safety flights because the flights are infrequent and have clear community value. However, they historically oppose other uses due to noise. While the federal government directly regulates airspace and airspace operations, state and local governments determine where and when aircraft can take off and land through a variety of mechanisms. It is through these mechanisms that local groups could severely limit eVTOL/UAM operations for reasons of noise generation as well as privacy and safety concerns. **BCA**



Another novel NASA-proposed solution included using the space within roadway cloverleaves in Silicon Valley as verti-stops. Aircraft approach and departure trajectories could be performed over major roadways with no flights over neighboring private property. Existing highway noise would limit community annoyance.

including Georgia Tech's are working with Uber Elevate to conduct system safety analyses and more UAM market studies. The University of Texas at Austin is investigating the fabrication and testing of stacked co-rotating propellers, and the Ecole Polytechnique is studying integrated urban mobility. Hillwood, a large commercial real estate developer, is also partnering to develop

skyports across North Texas.

Signature Flight Support announced it was partnering with Uber at the Washington Uber Elevate summit. That prompted Eric Allison, head of Uber Elevate, to note that, "Efficient and safe skyports are a critical component of our business model, and our future collaboration with Signature will allow for a seamless rider experience from the

moment they arrive at an Uber Elevate Skyport to the moment they depart."

Managing Movement

Uber has also signed a Space Act Agreement with NASA for developing systems to manage drone traffic. Successful, optimized on-demand urban eVTOL/UAM operations will involve numerous aircraft flying at low altitude over metropolitan areas simultaneously, so traffic control is key. In order to handle this exponential increase in complexity, new ATC systems will be needed. Current air traffic management equipment such as ADS-B is sufficient for relatively low-density operations, but more comprehensive low-altitude airspace solutions will be required.

According to Elwell, the FAA and NASA will be working together next year on what he called the "UAS grand challenge," which he went on to describe as "bringing together the best and brightest minds from government and industry to begin live testing of carefully designed scenarios to show how a variety of vehicles and airspace management systems will or won't work together." He said the objective is to manage low-altitude operations "through a server request-like system that can deconflict the global traffic, while allowing UAVs and eVTOL to self-separate any potential local conflicts with VFR-like rules, even in inclement weather."

Three compelling developments are needed to unlock the operational efficiency of any ATC system managing low-altitude aircraft in urban environments: high-volume voiceless ATC interactions; UTM-like systems that address "higher altitudes" intersecting with manned, general aviation aircraft; and eVTOL or UAS traffic integrating seamlessly with commercial airline approach and departure corridors near metropolitan airports.

The Los Angeles metroplex is covered with Class B, C and D airspace. One report states, "most of this controller-managed airspace is rarely utilized. . . . An MIT [Massachusetts Institute of Technology] study found that airline operations only access 5% of this airspace." Such data suggest that it may be possible for hub airport airspace to embrace "cut-outs" allowing non-controller managed flights, which roughly sounds similar to the locally infamous VFR corridor over Los Angeles International Airport (KLAX). This type of airspace



UBER

Time-Saving Key

Every day, millions of driver hours are wasted on traffic-jammed roads worldwide. Last year, the average commuter in the San Francisco area spent 230 hr. commuting between home and work. That is half a million hours of productivity lost every single day by Bay area workers. In Los Angeles and Sydney, residents spend seven whole working weeks each year commuting, two of which are spent stuck in gridlock.

This is why eVTOL/UAM advocates believe their aircraft will be embraced by the public — vehicles that give people back time otherwise lost in their daily ground commutes. NASA and Massachusetts Institute of Technology (MIT) Urban eVTOL studies show a three to four times trip speed multiplier could be achieved in highly congested metropolitan areas during peak travel periods using such aircraft.

One case study provides an example of the potential. Commuting from downtown San Jose to San Francisco's Marina District via ground vehicle can take 1 hr., 40 min. (or more) for the 57-mi. trek. The Caltrain rail service takes 2 hr., 12 min. In contrast, an eVTOL/UAM flight would cover that distance in 15 min. **BCA**



The Lillium Jet's sleek profile is designed to travel up to 300 km in just 60 min., using less than 10% of its maximum 2,000 hp during cruise flight.

management approach would embrace dynamic allocation instead of fixed airspace boundaries.

Nix on Noise

For urban air transportation to thrive, the vehicles must be acceptable to communities, and vehicle noise plays a significant role. One negative attitude toward eVTOL aircraft springs from the lengthy battles residents of many communities around the world have waged with helicopter operators due to noise. (See "Not in My Backyard" sidebar.) The eVTOL advocates will need to fight hard to shed any connection with the loud and annoying clatter so typical of helicopter flight, especially when hovering or approaching and departing downtown heliports. As explained later, design factors incorporated in eVTOL machines promise to dim that din.

During the research for a previous article on the London Heliport ("Center of Attention," *BCA*, October 2014, page 56), this author reviewed citizen criticisms in a formal noise complaint system used by London authorities to manage the helicopter noise problem, and there were literally hundreds of them involving that lone facility. City denizens get deeply angered when helicopter rattle awakens the sleeping weary at oh dark thirty. Citizens in the LA Basin, irritated with the impression that the FAA can't "solve the noise problem," have taken their anger over helicopter noise to the congressional level as have their East Coast counterparts in the Big Apple.

For communities to accept sizeable fleets of eVTOL aircraft, vehicle noise will need to blend into the everyday city clamor wherever they fly. Uber Elevate maintains that eVTOL aircraft should emit no more than half the noise of a

medium-size truck passing a residence (75-80 dBA at 50 ft.). According to an Uber Elevate white paper, a reasonable goal for an eVTOL is to generate no more than 67 dBA at ground level when flying at 250 ft. AGL, or approximately the same as a Toyota Prius when passing within 25 ft. of a listener at 35 mph. The Uber Elevate report emphasizes the importance of its noise goal by not increasing the long-term average Day-Night Level (DNL) by more than 1 dBA, which is the smallest change in loudness that a person can detect.

Mike Hirschberg, executive director of the Vertical Flight Society (formerly the American Helicopter Society Inc.), discusses a number of design features in eVTOL aircraft that should help ameliorate the sound signature to near this goal. The first is the number of blades. The greater the number of blades, the lesser the sound, resulting from a reduction of "blade

loading." Second is that the average gross weight of an eVTOL aircraft is anticipated to be far less than that of conventional helicopters.

Also, tip speed is a large factor in noise energy. Basically, the faster that a rotor tip travels, the greater the racket produced. Noise increases with about the fifth to sixth power of tip speed, so a blade with 1.5 times the tip speed will produce eight to 12 times the noise energy. It is possible with eVTOL rotor systems to realize tip speeds of about half those of helicopters without blade stalling.

Another noise factor is aircraft propulsion. Helicopter engines are generally as loud as the rotor and heard as a spectrally distinct noise source, further increasing the sound impact. The electric power intended for eVTOLs and many UAVs will be critical to low noise emissions since it enables ultra-quiet designs, both in terms of engine and thrust. Electric motors are far quieter because they don't ingest and expel large volumes of air through hydrocarbon combustion. So, substituting them for conventional engines eliminates a significant sound source.

In addition, tail rotor noise is annoying to humans because its higher frequency as compared to that of a helicopter's main rotor's noise delivers sound in the hearing spectrum to which human ears are the most sensitive. To date, most eVTOL/UAM designs dispense with tail rotors altogether and should be able to follow approach profiles that minimize their sound signatures.



Airbus conducted the first flight of its all-electric and self-piloted Vahana on Jan. 31, 2018 at the Pendleton, Oregon, airport.

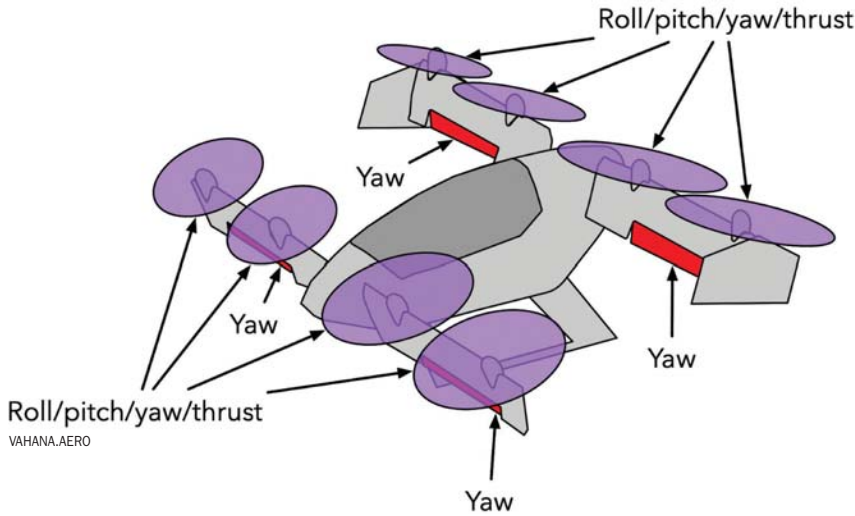

Airbus first flew its all-electric and self-piloted Vahana on Jan. 31, 2018. A core premise of the project is that full automation and sense-and-avoid technology will allow higher safety levels by minimizing human error while allowing more vehicles to share the sky.

The development of such aviation infrastructure would likely cost significantly less than, say, building roads, bridges, tunnels and light rail systems. Aside from existing helipads, among the sites proposed are the tops of parking garages and even unused land at highway interchanges. Los Angeles has more than 40 high-rise helipads in the immediate downtown area, and according to the FAA, there are 138 heliports in the LA Basin. Cities such as San Francisco also have many high-rise building helipads, but local ordinances severely restrict their use primarily because of noise concerns.

A NASA study considered using floating barge “vertiports” in San Francisco to provide approach and departure

Inadequate Infrastructure

Among the more significant barriers to deploying eVTOL/UAM aircraft in metro areas is a lack of sufficient locations to place operating bases. Most cities simply don’t have the necessary takeoff and landing sites for the vehicles

to operate at fleet scale. A small number of cities have heliports and might have enough extra capacity to offer a limited service for this new generation of aircraft — that is, provided they are in the right locations, readily accessible from street level and have the space to add charging stations.

AVIATION WEEK Fleet&MRO FORECASTS

COMMERCIAL | BUSINESS | HELICOPTERS | MILITARY

Get a sneak peek at the
**2020 Business
Aviation Forecast.**
Sign up for a
demo now.

Predicting market opportunity simplified.

With Aviation Week Network’s forecasting tools you’ll have fingertip access to:

- Fleet, trends, and projections
- Opportunities
- MRO future demand

For more information on Aviation Week Network’s Fleet & MRO Forecasts

go to pgs.aviationweek.com/2019Forecasts
or call 866.857.0148 or +1.847.763.9147



AVIATION WEEK
NETWORK



to the FAA's Elwell, these embody "some of the most exciting innovations and developments in aerospace since the Wright brothers."

What follows is a sampling of some such innovations, beginning with distributed electric propulsion (DEP).

This technology uses multiple — typically six or greater — electric motors, controllers and a redundant battery bus that obviates the problems of catastrophic engine failure. According to the Vertical Flight Society's Hirschberg, this creates new design freedoms by allowing power distribution through

Lilium, a Munich-based startup, first flew its five-seater Lillium Jet on May 4, 2019. An all-electric tilt-jet design, it features 36 engines mounted and no tail, rudder, propellers, gearbox and only one moving engine part. The company says the aircraft can travel up to 185 sm (300 km) in 60 min.

electrical cables instead of failure-prone driveshafts. An engine failure in an eVTOL/UAM aircraft might result in diminished speed or climb capability, but full control authority within the aircraft's operating envelope can be maintained. By avoiding the use of a large rotor, a DEP aircraft is also able to take advantage of a whole aircraft parachute system.

DEP provides not only redundancy, but it has the potential for additional control robustness so that any component can fail gracefully, enabling a controlled landing. It can also help with high wind or gust conditions, especially when operating in an urban environment where local flow disturbances are commonplace.

paths over the water that limit community annoyance and risk, as well as avoiding problems with buildings in the tightly packed downtown. Another novel NASA proposal included using the space within roadway cloverleaves in Silicon Valley as verti-stops. Typical cloverleaves were found to be approximately 225 ft. in diameter, compared with FAA guidance documents that require a 50-ft. pad, a 115-ft.-diameter Final Approach and Touchdown (FATO) Area, and a 200-ft. Public Safety Area. Aircraft approach and departure trajectories could be performed over major roadways with no flights over neighboring private property. Existing highway noise would theoretically mask that generated by the aircraft and thus limit community annoyance.

critical economies of scale. By comparison, eVTOL/UAM proponents envision those simpler, smaller, quieter aircraft to soon number in the hundreds of thousands, thus driving their costs down to everyman affordability levels.

Right now, many companies are testing a wide variety of eVTOL/UAM aircraft in the U.S. and abroad. According

Revolutionary Designs

Helicopters are the closest proxy to eVTOL/UAM aircraft, but they are considered by many to be too expensive, too loud, too complicated and too inefficient to operate as part of a large-scale urban transportation service. Accordingly, demand results in relatively low manufacturing volumes, and thus the type lacks

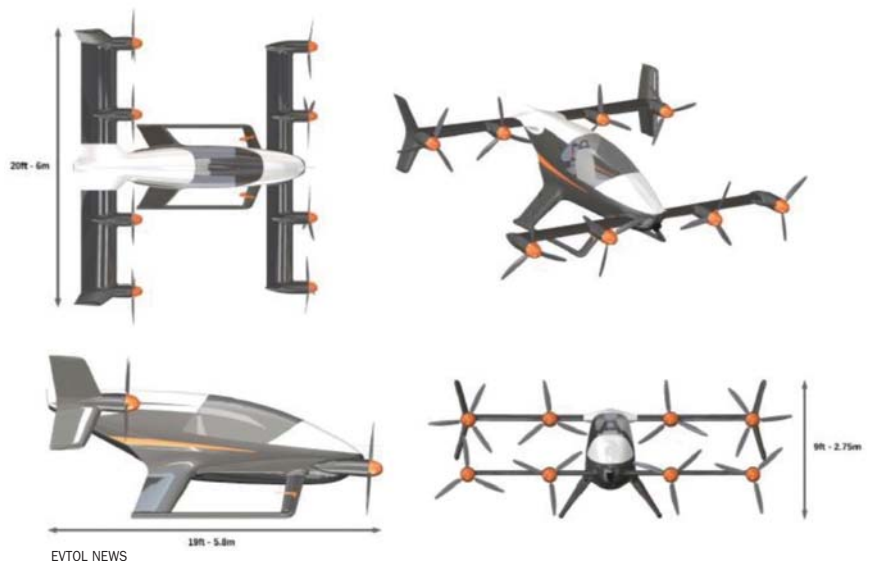

Electric motors are typically able to increase their power output by 50% for 1-2 min. before overheating. This capability could be held in reserve for emergency operations such as a motor failure. For a DEP eVTOL/UAM aircraft with six prop rotors, failure of a single motor causes a reduction in thrust of about 17%, with the peak ratings of the other electric motors providing greater than this reduction during the loss of the one engine. Even though helicopters are able to autorotate, this does not work well in dense urban areas from low altitude because the poor glide ratio of helicopters limits the emergency landing within a short distance.

A problem inherent with a near-vertical descent by a helicopter is the danger of entering vortex ring state. By contrast, an eVTOL/UAM aircraft will likely have a higher downwash velocity that permits a more rapid descent, and when used in combination with multiple prop-rotors it will help to avoid rotor recirculation flow conditions, which is entering vortex ring state.

Electrical propulsion has many desirable characteristics that make it the preferable choice for eVTOL/UAM aircraft. The amount of energy per unit weight of batteries today is insufficient for long-range commutes and the charge rate is still too slow to support high-frequency ride-sharing operations. Meanwhile, the aircraft will likely employ large battery packs, nominally a 140-kWh pack for a four-person aircraft. Trip range is extended if the infrastructure supports recharging even for just a few minutes with high-voltage rapid rechargers as passengers board or exit the aircraft. Notably, the Energy Department's Battery 500 project is spending \$50 million over the next five years to develop 500-Wh/kg batteries along with high-capacity chargers.

Getting Certified

In his speech, the FAA's Elwell highlighted the importance of ensuring safety through the certification process. He said, "What you see is the ideal

way to transport people across cities. When I look at it, I see car-sized vehicles with multiple rotors hanging over dense urban populations. That is the challenge — taking an industry of incredibly bright minds and fast-moving technology and joining that with a regulatory agency that wants innovation, but only if it can be brought safely into an urban environment."

He said, "Performance-based rules will ultimately form the backbone for how UAM vehicles will be built. For new entrants, we started with our legacy regulatory framework but have evolved to an operations-first approach. We use existing rules where we can and derive new rules where we need."

And in July, the European Aviation Safety Agency (EASA) released the first building block to enable the safe operation of hybrid-electric and eVTOL aircraft. Patrick Ky, EASA's executive director, declared, "We are actively engaging with the industry to develop the right technical requirements to take benefit of the new technologies

AircraftBluebook⁺
JET APPRAISALS

Performed by
Accredited
Senior Appraisers



877.531.1450 /
aviationweek/jet-appraisals

Desktop Aircraft Appraisals / On-Site Asset Verification and Logbook Review /
Residual Values / Customized Analysis

AVIATION WEEK
NETWORK

High-Visibility Urban Accidents

One of the major obstacles that eVTOL/UAM advocates face is convincing a wary public that their aircraft pose little risk.

Understandably associated with helicopters, the time-saving promise of these new aircraft pales whenever a helicopter crashes in or near a city, further highlighting the risk posed by rotary-wing aircraft in congested, urban settings. The June 10 crash of a helicopter, fatal to its pilot, the lone occupant, atop a New York City office building catapulted the danger into the national limelight, even prompting presidential tweets.

Headlines the day after read, “Deadly Manhattan Rooftop Helicopter Crash Raises Safety Questions About Choppers in the City” and Mayor Bill de Blasio said non-emergency helicopters should be banned altogether from Manhattan.

The accident recalled another in May 1977 when shortly after touching down on the roof of the Pan Am building, a New York Airways Sikorsky S-61L suffered a main landing gear failure that caused all main rotor blades to strike the concrete helipad. Four passengers who were waiting to board were

struck by the blades and killed. One of the blades crashed through an adjacent office window and another fell to the street below, killing a pedestrian.

Such accidents provide plenty of fodder for city residents to loudly protest such operations, and their elected officials are listening. Immediately after the recent accident in Manhattan, U.S. Rep. Carolyn Maloney (D-NY), whose district includes a large swath of midtown Manhattan, also called for a ban on “nonessential” helicopter flights over the city, saying, “We cannot rely on good fortune to protect people on the ground. It is past time for the FAA to ban unnecessary helicopters from the skies over our densely packed urban city. The risks to New Yorkers are just too high.”

The safety goals stated in Uber’s White Paper are laudable, and clearly there are design aspects of eVTOL/UAM aircraft that appear to have significant potential to lessen the accident types common in rotorcraft operations, but the new segment’s proponents have much work to do to convince a skeptical public to welcome their new form of aircraft. **BCA**

bringing safety and environmental benefits to the community. The establishment of a common set of conditions for the certification of these new concepts of vehicles will enable a fair competition on the European market as well as clarity for future manufacturers and their investors.”

As already demonstrated, eVTOL/UAM aircraft will be manufactured, flown and maintained under the more stringent levels of control and FAA oversight of FAR Part 135. Most of those operations, at least until autonomous operations become commonplace, will require crewing by commercial pilots who must have a higher level of training, experience, flight review and medical certification. As on-demand eVTOL/UAM service scales up, the need for pilots will increase, further exacerbating the

current shortage of qualified — 500 hr. as PIC for VFR and 1,200 hr. for IFR — commercial pilots.

‘Crawl, Walk, Run’ Development Philosophy

Elwell offered a broad timeline for bringing eVTOL/UAM aircraft into public service, telling Uber Elevate attendees, “Let’s begin this integration by working with industry to start crawling with low-risk operations in remote areas, gathering data and evaluating safety. When we are ready, we will graduate systematically to high-density urban areas with semi-autonomous operations, and eventually the system will mature to fully autonomous operations in busy urban airspace.”

That timeline and experience allows users and regulators to become more comfortable with the technology and

to examine statistical proof that autonomy provides high levels of safety. Only once so satisfied will they welcome this new category of aircraft into the city limits.

NASA and the FAA are actively working to bring together eVTOL/UAM manufacturers, federal agencies, private investors, professional societies, universities and international aviation organizations to identify barriers to launching on-demand service. Advocates need to mobilize private sector investment to develop related infrastructure that benefits consumers, communities and sustainable operations. Just as importantly, operators must proactively engage with local resident communities and with local, state and national governments to mollify concerns over noise, safety and private impacts. **BCA**



All About Jet Bla



Tourists brave the jet blast at Maho Beach, St. Maarten, to watch airplanes land on Runway 10 at Princess Juilana International Airport (TNCM).



Imagine landing late at night at any airport like Chicago O'Hare International (KORD), requesting and being granted the most expeditious taxi route to your ramp. Once underway, quite suddenly your King Air is violently lifted off the ground and flipped upside down. This actually happened,

unfortunately with a fatal ending.

This invisible disturbance, formally called "jet efflux hazard," but best known as "jet blast," is created by turbine aircraft engines and can be powerful enough to cause large upsets to aircraft on the ground or close to the ground. Paragraph 7-3-1-b of

the Aeronautical Information Manual (AIM) states, "During ground operations and during takeoff, jet engine blast (thrust stream turbulence) can cause damage and upsets if encountered at close range. Exhaust velocity versus distance studies at various thrust levels have shown a need for light aircraft to

st

A potential hazard on ramps, taxiways and runways

BY PATRICK VEILLETTE jumprsaway@aol.com



ELAINE GREENAN

maintain an adequate separation behind large turbojet aircraft. Pilots should be particularly careful to consider the effects of their “jet blast” on other aircraft, vehicles and maintenance equipment during ground operations.” Ramp areas, taxiways and runway approach ends tend to be the airport locations where jet

blast incidents are most common.

When modern jet engines are operated at takeoff power settings, the exhaust wake can exceed 325 kt. immediately aft of the engine exhaust nozzle. At the tail of the Boeing 737-600, the core of the exhaust is still traveling over 250 mph. (See photo titled “Takeoff Thrust, Boeing 737-600, -700, -800 and -900 Series.”)

Be aware that today’s large aircraft with two powerful turbofan engines have greater installed thrust and potentially longer hazard areas than the four-engine widebodies. The exhaust extends aft in a rapidly expanding cone, with portions of the flow field contacting and extending aft along the pavement surface.

If you have any doubt about the power of jet blast at an extended distance behind a transport jet, just go to <http://www.youtube.com> and insert “St. Maarten Airport takeoff jet blast” to see thrill-seekers on the beach and hanging on to the airport fence taking on the full force for fun.

While exhaust velocity decreases with increasing distance from the engine exhaust nozzle, it can still create a hazard even hundreds of feet behind the

aircraft. At full power, the exhaust wake speed can be 100 mph at 150 ft. beyond the tail of a Boeing 737-600, and 50 mph well beyond 220 ft. This is more than strong enough to lift trucks, damage roofing, move unsecured objects and lift untethered aircraft. United Airlines produced a training video for its crewmembers to illustrate the importance of maintaining situational awareness of the presence of vehicles behind an aircraft. It can be viewed at <https://www.youtube.com/watch?v=DFP4x10V0mk>.

Idle Thrust and Ramp Concerns

An idling Boeing 737-300 can produce a jet blast of 35 mph at 100 ft. behind its tail. (See photo titled “Idle Thrust, Boeing 737-300, -400 and -500 Series.”) An idling Bombardier CRJ produces a jet blast with a velocity of 60 mph at 60 ft. behind the engines. (See photo titled “Jet Blast Velocities Behind CRJ Regional Jet.”) These velocities have

Cessna recommends clearing an area of personnel and equipment 100 ft. behind the CJ-4 prior to engine start or during idle.

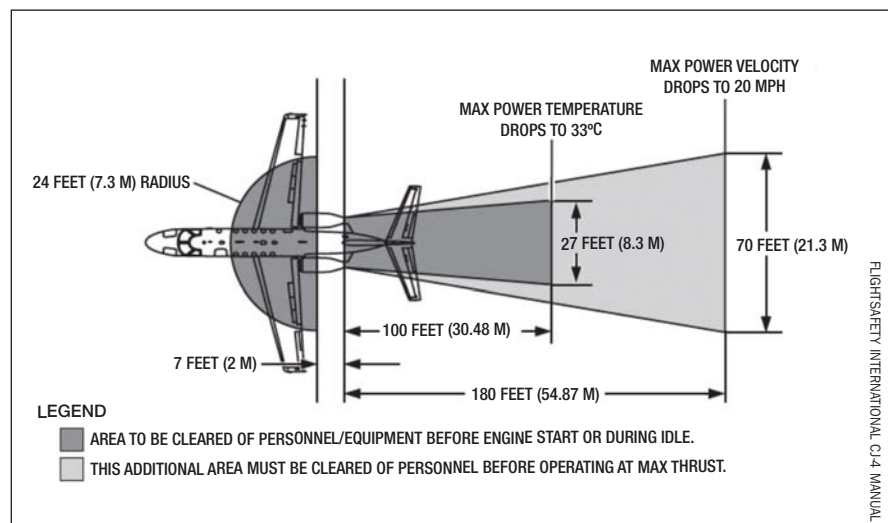

caused damage to nearby structures and aircraft, tipped over and moved heavy objects, broken windows adjacent to aircraft ramps and/or injured persons on the ramp. Since ramp spaces are rather tight, substantial damage has been caused by jet blast to nearby parked aircraft.

While most attention is given to the powerful jet blast behind large transports, business jets and turboprops create jet blast (or prop blast) sufficient to cause substantial damage in their blast zones as well. The blast from business jets has caused serious injuries to ramp workers when pilots applied too much thrust in the ramp area to begin taxiing and/or to maintain speed during the sharp turn out of a parking spot. Cessna recommends that a distance of 100 ft. behind a CJ-4 be cleared of personnel and equipment prior to engine start or during idle power operations.

The NASA Aviation Safety Reporting System (ASRS) contains reports of light aircraft owners unable to temporarily control their aircraft when positioned behind a business jet or large turboprop that was starting its engines. Your visual scan when taxiing on a ramp should watch for rotating beacons, a universal signal that another aircraft has operating engines (or is about to start its engines.) If you notice

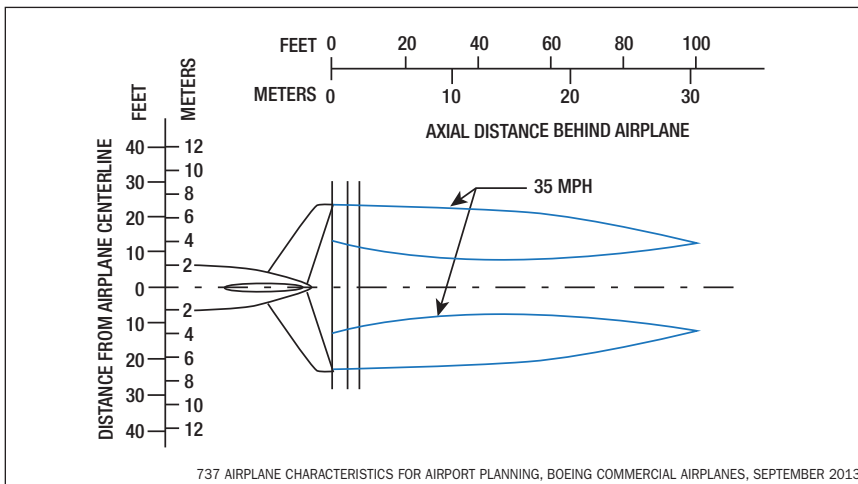

Idle Thrust, Boeing 737-300, -400 and -500 Series

a rotating beacon on a jet or turboprop while you are about to taxi by, or if your aircraft is positioned close behind such aircraft, you may want to tie it down or stop your taxi motion until you assure you have sufficient distance or time to let the blast dissipate.

Engine inlets represent a potential personnel hazard as well since once their engines are operating they can ingest things other than air. Airplane reverse-thrust operations and the use of reverse thrust to move an airplane will increase the power hazard area and require particular care to ensure that people and equipment are

adequately protected.

It's always a good policy to keep the ramp free from obstacles just to prevent congestion and the risk of collision, and the hazard of jet blast whisking a baggage cart across the ramp is yet another reason we should strive to keep the ramps clear.

Getting Going

Aircraft need a bit of extra thrust to get the wheels rolling during the initial part of their taxi. Jet blast velocity can increase two or three times as the throttles are advanced to "breakaway" thrust to begin taxiing. Behind the Embraer ERJ-175 the core of the jet blast has a velocity exceeding 115 mph behind the tail. (See photo titled "Breakaway Thrust for Newer Regional Jet.") At distances greater than 220 ft. behind the tail of a Boeing 737-600 series, the core of the jet blast still retains 50-mph velocities. (See photo titled "Breakaway Thrust, Boeing 737-600, -700, -800 and -900 Series.")

According to an analysis of jet blast incidents, the NASA ASRS system determined there is often no appreciation by the flight crews of large aircraft of the potential hazard to smaller aircraft that is created by the application of "breakaway thrust" to commence moving. Light aircraft, as well as regional and business jets, operating at busy airports with frequent widebody aircraft movements are at particular risk.

The highest risk from breakaway thrust occurs when a lighter aircraft is on the takeoff or landing roll as it passes behind a jet that has just stopped to clear the active runway and is applying breakaway thrust to resume taxiing. This can result in a loss of directional control and runway excursion.

BREAKAWAY THRUST FOR NEWER REGIONAL JET

Breakaway thrust for the Embraer ERJ-175 shows that an area of high velocity extends to the tail and past. Zone C's velocity is 118 kt.

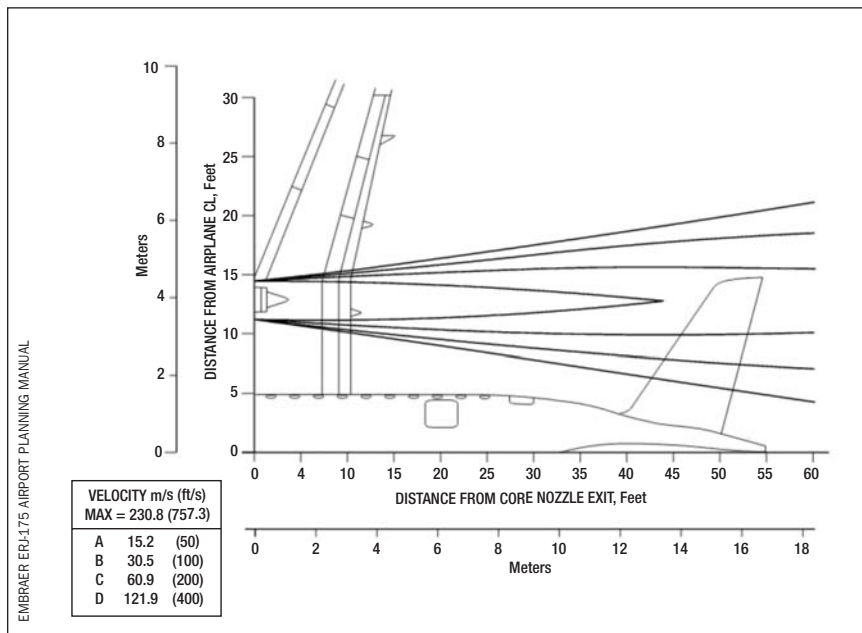

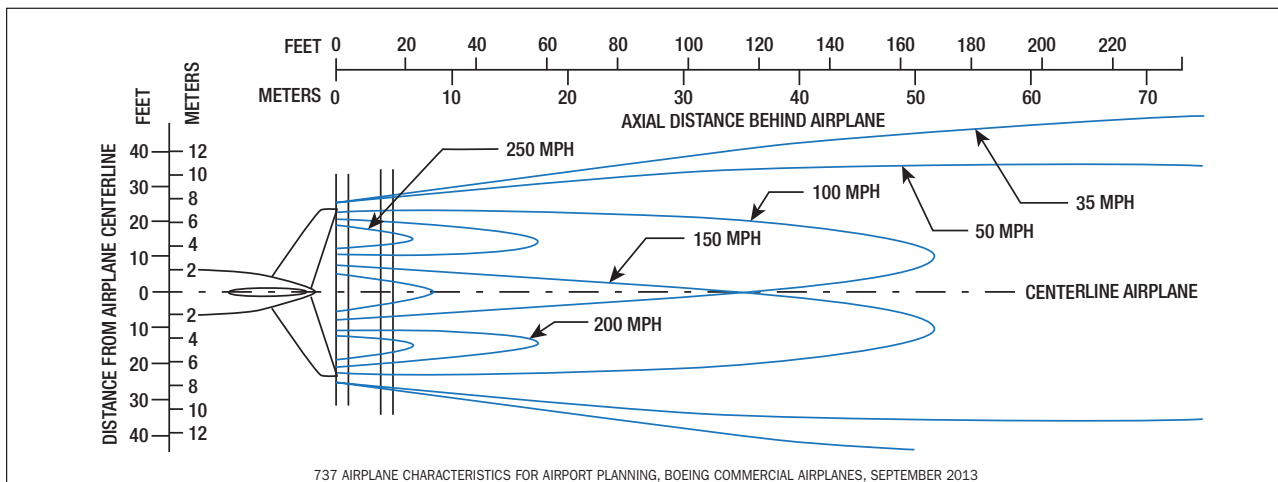

TAKEOFF THRUST, Boeing 737-600, -700, -800 and -900 Series

Breakaway thrust is also a problem in the ramp area as an aircraft needs the additional power to taxi and/or maintain sufficient momentum during the tight turns often required upon leaving a parking spot. The jet blast zone for

breakaway thrust extends significantly farther than the recommended protection zone for idle thrust, and the sweeping 90-deg. turn often performed when leaving a parking spot will blast a wide swath of the ramp with high velocity hot

gases that have caused extensive damage and serious injuries.

Several special situations occur on ramps in which flight crews of heavier aircraft are asked to exhibit a higher awareness. If breakaway thrust is not

Need a Tow

On Oct. 29, 1997, at 1706 Central Standard Time, a Cessna 150M was substantially damaged after being rolled over by jet blast while taxiing behind a Boeing 727-231 at San Antonio International Airport (KSAT). Neither the flight instructor nor the student within were injured. The Cessna had just landed after conducting a local training flight and was taxiing back to the ramp when the accident occurred.

The student had landed the airplane on Runway 12L and exited it at Taxiway Alpha. The taxi clearance from Ground Control (GC) involved passing behind the taxiing Boeing trijet, which was passing in front of them from left to right, on another crossing. The Cessna held short to allow the 727 to pass in front of them. Once past, the 727 came to a complete stop at the intersection with Runway 12L.

The Cessna then advanced as cleared behind the Boeing, but as this was occurring, GC cleared the 727 to proceed across Runway 12L and it throttled up to do so. Unfortunately, at that moment the Cessna was in the path of the Boeing's jet blast, which lifted it completely off the ground and rotated it to the right. The airplane struck the ground with the left wingtip and propeller and came to rest upright, facing the opposite direction of the taxiing 727. Inspection of the aircraft by an FAA inspector revealed that the right wing spar was structurally damaged.

The following is an excerpt from a certified transcript of the ground communications during the event:

1704:52 (Ground Control): "Cessna 9182U, you got the 727 in sight? You can hold for him or taxi down the taxiway and make a left turn on November, your choice."

1704:59 (N9182U): "82U, we'll hold for him."

1705:01 (Ground Control): "OK, pass behind him. Use caution, you got company coming out."

1705:05 (N9182U): "Behind the 727, then we'll stay to the right for that outbound traffic."

1706:24 (Ground Control): "TWA 4333, cross Runway 12L, hold short of 12R."

1706:29 (TWA 4333): "Roger, crossing 12L, holding short of 12R."

1706:32 (Ground Control): "82U, caution jet blast, he's moving."

1706:35 (N9182U): "82U."

1706:48 (Unknown): "[unintelligible] are you guys OK?"

1706:50 (Ground Control): "9182U, you all right?"

1706:52 (N9182U): "82U, we're fine."

We're going to need somebody to tow this plane off."

The NTSB determined that Ground Control's taxi clearances to all of the aircraft involved were given in compliance with applicable FAA guidelines for ground movement of aircraft. Both the Cessna and the Boeing 727 complied with their respective taxi clearances. The pilot of the Cessna stated that he had taxied behind large aircraft before at the same place, and with similar taxi clearances. He also stated that he would have not proceeded behind the 727 if he was aware that the jet was powering up from a "dead stop." **BCA**

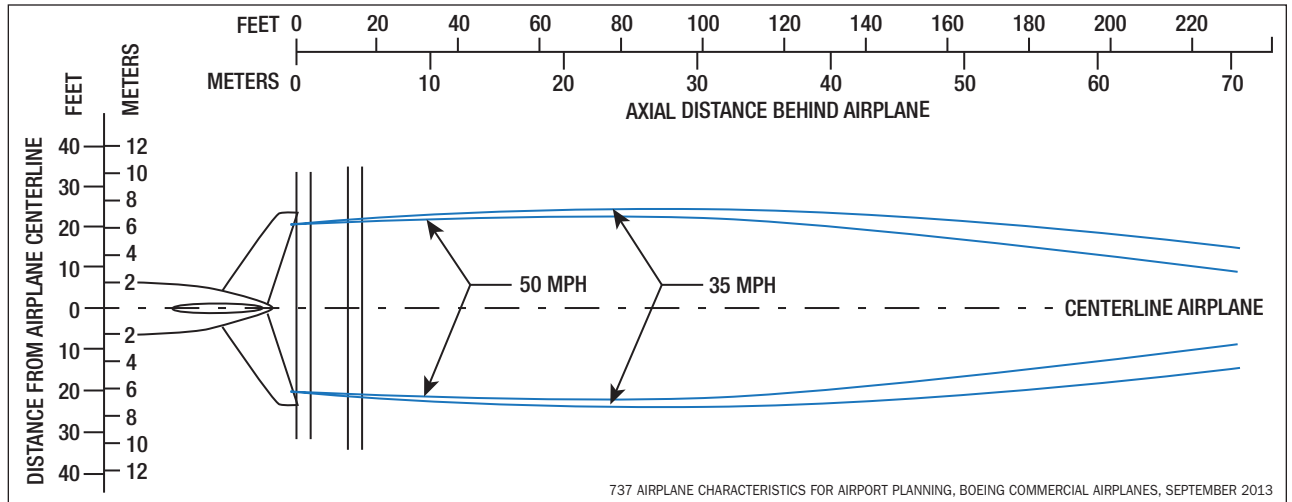

sufficient, they are asked advise ATC of needing to apply more thrust. ATC can then hold or divert traffic passing behind. Since cross-bleed engine starts produce more than normal thrust, these should be carried out with caution.

Taxi Trouble

Taxiways are a second common area for jet blast incidents. While the transport is taxiing, it doesn't require as much power as the "breakaway." However, if the transport comes to a stop, you should definitely be aware of the distance. When the pilot of the transport chooses to begin taxiing again, it takes a definite increase in the power to get the aircraft rolling from a dead stop versus

the power required during a steady taxi speed. So, once a stopped transport is cleared to begin taxiing forward, the jet engines are going to put out a strong initial blast. Many transport aircraft pilot manuals contain cautions about using the minimum required power on ramps and taxiways, and to maintain an awareness of obstacles that may be damaged by their jet blast. If you are following a transport, leave a sufficient distance.

Larger aircraft ahead of us on the taxiway aren't the only aircraft whose jet blast can affect us. While taxiing, we should always maintain our positional awareness with respect to other aircraft adjacent to the taxiway or when approaching intersections. Larger aircraft may be doing engine run-ups and

BREAKAWAY THRUST, Boeing 737-600, -700, -800 and -900 Series

facing in a direction such that their jet blast will flow across our taxi route.

Light single-engine aircraft have been rolled over on the ground by transport aircraft at crossing intersections when the transport was taxiing under a heavy load and high power. Other single-engine aircraft have been rolled over when a transport turned in front of them at a high power setting near a taxiway intersection.

There are a couple of precautions you should take on taxiways. Don't be afraid to give enough room between your aircraft and the transport when it stops. Monitor the appropriate radio frequency

Maintenance Run-Up Hazard

High engine thrust during maintenance activity can cause considerable damage to airplanes and other elements on an airport. An example of the problem occurred at night when the pilot of a Beech 58 returned to Chicago O'Hare International Airport (KORD) on March 13, 1985. After landing, the pilot requested clearance to the TWA hangar and was cleared on the most expeditious route, which passed by a pad where a maintenance crew was running up the engines on a Boeing 747. The resulting jet blast from the Boeing 747 blew over the Baron as it passed behind, crushing its top and killing the pilot. (NTSB accident report CHI85FA138)

The Beech pilot had not been cautioned about the possible jet blast and the Boeing maintenance crew had not been advised of the light twin's position.

For reasons of noise abatement, the nighttime run-up of the Boeing should have been conducted on a heading

of east or northwest, but the 747 was on a heading of southwest, angled into the wind. None of the four tower controllers detected or attempted correcting its orientation. Furthermore, a letter of operations prohibited the use of the taxiway next to the pad when it was being used for run-ups.

The NTSB found the control tower service to have been inadequate, ATC instructions improper and that ATC had failed to follow directives, and that the Beech pilot's planning had been improper.

Operators should refer to the procedures, practices and precautions in the applicable aircraft maintenance manual when developing their operating specifications, operations, maintenance and engineering practices. The aircraft general sections detail safe practices covering airplane ground operations, taxiing, engine power hazard areas and precautionary practices to be observed during maintenance activities that require engine operation. **BCA**

TakeOff

NORTH AMERICA 2019

Achieve your air service development goals

28-29 October
Orlando/Sanford, Florida



Negotiate with senior representatives from the region's aviation community and grow important business relationships at the event dedicated exclusively to the North American marketplace.

Contact Paul.Hibbert@ubm.com for more information or to book your place.

TakeOffNorthAmerica.com



Destination Sponsor

AVIATION WEEK
NETWORK

JET BLAST VELOCITIES BEHIND CRJ REGIONAL JET

Even at the distance of a football field (300 ft.), the jet blast velocity behind a CRJ is still 60 mph. Behind an idling CRJ the jet blast has a velocity of 60 mph at 60 ft. behind the engines.

to anticipate changes in the transport's direction and speed. Never assume that the captain of the large transport knows you are there. He doesn't have rearview mirrors in his aircraft and the flight crew of the transport will be busy with their taxi and before-takeoff procedures. Don't be afraid to announce on the radio frequency your proximity behind the larger transport as a gentle reminder to the transport captain to be extra cautious when adding power to begin taxiing.

Jet efflux can dislodge sections of taxiway or stopway paving, or other debris, deflecting it rearward and upward, causing it to hit and damage aft portions of the aircraft to include the stabilizer and/or elevator. This can lead to impaired control authority, resulting in loss of control during rotation and initial climb.

This scenario occurred to a Trans International Airlines DC-8-63F, N4863T, Ferry Flight 863. The four-engine Douglas crashed during takeoff at New York's John F. Kennedy International Airport (KJFK) on the afternoon of Sept. 8, 1970, killing the 11 crewmembers on board.

According to the NTSB accident report (NTSB-AAR-71-12), the introduction of the then-new large jet aircraft to the sprawling facility "... caused considerable erosion along most taxiways and runways. The products of this erosion, pieces of asphaltic material, rocks, etc., were being blown onto taxiways, ramps and runways, making it difficult to keep these areas clean by the New York Port Authority. Maneuvering surface cleanliness is the responsibility of the airport authority, but its major impact is on aircraft safety. Other than during scheduled airfield inspections, contamination may only be apparent to operating flight crew."

Approximately 1,500 ft. after starting its takeoff roll, the aircraft rotated to a nose-high attitude and at 2,800 ft. it became airborne. However, it continued to rotate slowly to an attitude of approximately 60 to 90 deg. above the horizontal at an altitude estimated to have been between 300 and 500 ft. The aircraft then rolled about 20 deg. to the right, rolled back to the left to an approximate vertical angle of bank, and

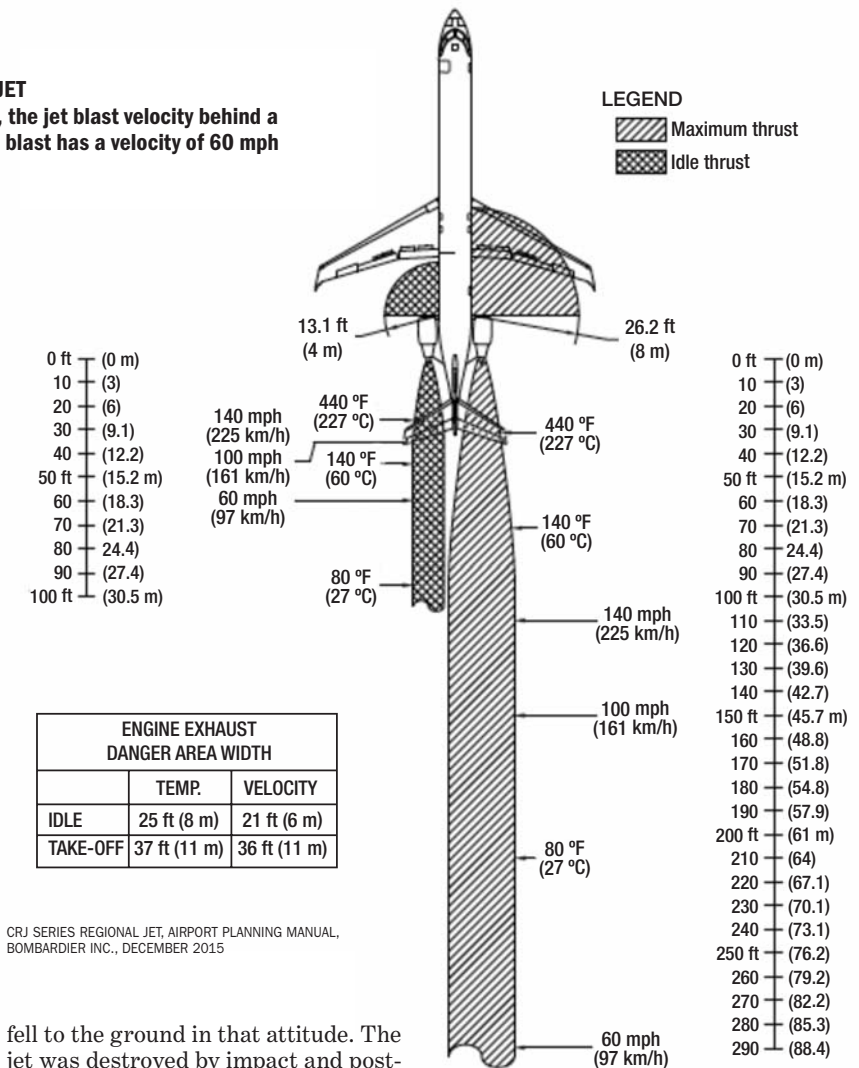

fell to the ground in that attitude. The jet was destroyed by impact and post-impact fire.

The NTSB determined that the probable cause of the accident was a loss of pitch control caused by the entrapment of a pointed, asphalt-covered object between the leading edge of the right elevator and the right horizontal spar web access door in the aft part of the stabilizer. The restriction to elevator movement, caused by a highly unusual and unknown condition, was not detected by the crew in time to reject the takeoff successfully. However, an apparent lack of crew responsiveness to the unique emergency situation, coupled with the captain's failure to monitor adequately the takeoff, contributed to the accident.

According to Boeing, even subtle foreign object damage (FOD) to the external portions of the elevator can change the surface balance and alter the air-flow characteristics in a way that may induce surface flutter. This dynamic and uncommanded movement of the surface can grow in both amplitude

and frequency, causing additional damage. Portions of the surface may be destroyed by the violence of the induced motion. If this motion is great enough, it can be coupled into the nearby airplane structure and cause collateral damage. In exceptional cases, control surface flutter could lead to loss of airplane control.

The high cockpit workload involved with taxiing includes running checklists, properly configuring the aircraft, accurately following ATC taxi instructions, avoiding a runway incursion, etc., and thus preoccupied, the crew may fail to consider their aircraft's jet blast on objects behind it.

The current industry advice on the matter is generally targeted on pilots of smaller aircraft in trail, counseling them to maintain a high degree of situational awareness to ensure they keep all wheels firmly on the pavement. **BCA**

AircraftBluebook[®]

PRINT & DIGITAL SUBSCRIPTIONS | APPRAISAL SERVICES | DATA LICENSING

CONVERSIONS &
MODIFICATIONS

SERIALIZATION
BY MODEL YEAR

MAINTENANCE PROGRAMS

NEXT GEN AVIONICS

TRUST

Know the Value

For over 65 years, Aircraft Bluebook has been the industry's go-to source for reliable and accurate aircraft valuations, providing in-depth data and information to the global business and general aviation community.



AVIATION WEEK
NETWORK

Visit aircraftbluebook.com for more info.



Contract Pilots

Taking the long view on short-term solutions

WITH MORE AND MORE BUSINESS AIRCRAFT PILOTS JOINING THE scheduled carriers, the importance and appeal of temporary contract pilots is gaining attention. What are the operational, insurance and legal considerations for these pilots and the companies that need them?

Operational: The operational issues are numerous. Does your company need a type-rated pilot in command (PIC), or a second in command (SIC) who can get qualified under FAR 61.55 quickly? There are plenty of flight time hungry pilots giving flight instruction, waiting to hit 1,000 hr. for restricted ATP or 1,500 hr. for a straight ATP. Your company will have to burn enough Jet-A to give this pilot the required three takeoffs and landings to be SIC, but the SIC that you create may not ask for much in the way of pay. However, are you willing to fly into New Jersey's Teterboro Airport (KTEB) with a copilot who hasn't experienced New York airspace? Do you have time to instruct on company flights?

PICs in the contract market often complain that they get little chance to learn a particular aircraft before flying it on the line. Type ratings typically cover a broad spectrum, and avionics packages can vary widely even within the same type aircraft. Legal to fly does not always equal safe to fly.

Insurance: "Approved" vs. "Insured." Many pilots believe that being an "approved" pilot under a company's aviation insurance policy gives them protection. It does not. In order for the insurance coverage to apply at all, the aircraft must only be flown by "approved" pilots. Therefore, if you fly for Acme Anvil Corp. and you are an approved pilot, then Acme is covered in the case of an accident. Unless you are also insured, the insurance may pay Acme following an accident, and then sue you to collect what the insurance company just paid to Acme. This is called subrogation. You need to be approved and insured, with a waiver of subrogation: then the insurance company cannot sue you for claims that they pay to, or for Acme, and the insurance company must provide you legal counsel and pay judgments on your behalf.

Policy language varies, so a pilot might be an "additional insured" a "named insured" or even an "additional named insured." In some situations as a contract pilot, you may also buy "non-owned aircraft" coverage, which insures you on a policy separate and apart from the company's policy. This should be a last resort. Typically, Acme won't get charged an additional

premium for adding pilots as additional insureds.

Legal: The FAA has issued a number of Legal Interpretations regarding contract pilots. The recurring theme is the agency's concern that the contract pilot is part of an illegal leasing scheme designed to circumvent the charter rules. The FAA has asserted that the contract pilot must make his/her customer acknowledge responsibility for operational control:

When you fly [Customer] and [Customer's] employees on [Customer's Bonanza] aircraft, if [Customer] does not acknowledge that you are [Customer's] direct employee or agent for the flight and does not acknowledge that [Customer] is liable for your actions or inactions, then [Customer] is not assuming operational control of the flight.

For legal history buffs, the operational control acknowledgment saga went like this: (1) acknowledgement of operational control civil liability was imposed on fractional aircraft owners pursuant to FAR 91.1013; (2) this responsibility was extended to FAR Part 91 operators in charter-management agreements through OpSpec A008; and then (3) this responsibility was extended

down to the Bonanza level of FAR Part 91 operations through FAA Legal Interpretations.

Ironically, the vast majority of "contract" pilots fly without any such formal agreement and those who do typically have an "independent contractor" document, which means they are NOT direct employees or agents. Usually these independent contractor contracts were not trying to conduct illegal charter, but rather simply trying to avoid tax problems for their customers. The solution is to have a contract explaining that the pilot is an agent for FAA purposes, and an independent contractor for all other purposes. That's not an elegant solution by any means, but rather an arrangement that reflects the awkward compromises that both pilots and operators must accept when utilizing contract pilot services.

The most common contract pilot complaint is pay. Not pay rate, because that is higher than ever, but getting paid at all. Contract pilots who agree to get paid after their service often find that even large, reputable companies may be very slow to deliver, and may impose administrative hurdles that delay payment for weeks or even months. The old adage remains true: No bucks, no Buck Rogers. Get the money up front. **BCA**

The most common contract pilot complaint is pay. Not pay rate, because that is higher than ever, but getting paid at all.

Know. Predict. Connect.



Business-critical information, predictive intelligence and connections with opportunities and people. That's how the Aviation Week Network helps you make decisions and build your business.

Delivering award-winning journalism, deep data and analytics, world-class events, and content-driven marketing services, our core principle is helping our customers succeed.

Let's grow your business.

AviationWeek.com/KnowPredictConnect

AVIATION WEEK
NETWORK

Know. Predict. Connect.



Hawker 900XP

Ultimate redux for the Grand Duchess de Havilland

THE HAWKER 900XP, THE 19TH AND FINAL ITERATION OF THE 1960 de Havilland DH125, the original midsize business jet, clearly was the strongest performer in the mark's 50+ year production run. Honeywell tailor made the 4,660-lb.-thrust TFE731-50, a special clipped-fan version of the second-generation 5,000-lb.-thrust TFE731-60, just for Hawker Beechcraft. From 2007 to 2012, 184 units were built.

Compared to the Hawker 850XP, its immediate predecessor, the Hawker 900XP had vastly improved hot-and-high take-off performance, plus the ability to climb directly to FL 410 when departing at MTOW. The 900XP's -50R turboprops were 4% more fuel efficient than the -5R engines of the 850XP, so range was increased by 200 nm to 2,755 nm with NBAA IFR reserves. Most operators say they can fly 6 hr. 45 min. missions and land with 1,500-lb. fuel reserves. But, that's only possible when cruising at 390 KTAS to 410 KTAS.

Its strong suit was full-tanks, full-seats loading flexibility, in keeping the Hawker tradition. Tanks full payload was 1,600 to 1,700 lb., depending upon BOW. Operators say the aircraft cruises efficiently at Mach 0.72 to 0.74 on most missions, but drag increases substantially above Mach 0.75. First hour fuel burn is about 1,950 lb., second hour is 1,350 lb./hr. and final hour is 1,200 lb./hr. Redlines are 310 KIAS/Mach 0.80. With only 20 deg. of wing sweep at quarter chord, plan on 400-kt. block speeds, about the same as for Citation XLS+ or Sovereign. Its 41,000-ft. certified ceiling makes it more vulnerable to westerly headwinds and weather build-ups than higher flying midsize jets.

With 604 cu. ft. of internal volume, cabin comfort is a strong suit. The standard layout features club seating up front and a single, forward facing chair on the right plus three-place divan on the left in the aft section. Optionally, the aircraft could be fitted with a second forward facing chair in place of the divan.

Up front, there's a full-service galley just aft of the entry door on the left side and 33-cu.-ft., 350-lb. capacity baggage compartment on the right side. There's another 16.5-cu.-ft. carry-on luggage bay in the aft lavatory. There is no external baggage compartment.

The cockpit features four-screen Rockwell Collins Pro Line 21 avionics. Most aircraft have been upgraded with WAAS/LPV capabilities and XM satellite radio weather. But, the flight deck is a mishmash of old and new, including a manual pressurization controller and legacy annunciator light panel. Rockwell Collins also furnished its Airshow 21 as the cabin management system. Most aircraft have the optional Iridium SATCOM phone, GoGoBiz WiFi and XM satellite radio entertainment systems, along with 120 volt AC power outlets.

Aircraft systems are simple and well-proven. Primary flight controls are manually actuated. Left and right starter-generators power the 28 volt DC, parallel buss, electrical system. Engine driven AC alternators provide power for windshield angle-of-attack anti-ice heaters. Long-life LEDs are used for most exterior lights and landing lights use high-intensity xenon bulbs.

Fuel is stored in 8,500-lb. capacity wet wing tanks and a 1,500-lb. capacity ventral aux tank. Engine driven pumps supply a single 3,000 psi hydraulic system that powers the landing gear, brakes, nose wheel steering, flaps, speed brakes, stall barrier stick pusher and thrust reversers. A dual-servo, bleed-air rudder bias system all but eliminates adverse yaw caused by asymmetrical thrust during one-engine inoperative takeoffs. The 8.5 psi pressurization system provides a 7,500-ft. cabin altitude at FL 410. The air-cycle machine pack is quite effective, even on the ground on warm days because of ample bleed air from the Honeywell 36-150 APU.

Wing and horizontal stabilizer leading edge ice protection is provided by a TKS fluid weeping pore system. The reservoir must be refilled through a port inside the aircraft. After use in flight, the system may continue to seep TKS fluid onto the hangar floor. The system must be checked every 30 days by maintenance technicians to insure that distribution lines and leading edge weeping pores are clear and functional.

The Hawker 900XP is comparatively maintenance intensive and it's not inexpensive to operate. Basic maintenance intervals are 800-hr. B, 1,600-hr. C and 3,200-hr. D inspections, plus 12-month E, 24-month F and 48-month G checks, plus 12-year landing gear overhauls. Landing gear overhaul runs about \$300,000. Engine midlife inspections are 3,500 hr. and overhauls are at 7,000 hr. MSP Gold is about \$317 per hour per engine.

Operators say dispatch reliability is rock solid, the aircraft is easy to fly and quiet, smooth and comfortable for passengers. Contaminated runway stopping performance is another asset because of the aircraft's lift dump flap system and powerful thrust reversers. Long travel main landing gear oleos provide touch downs so smooth that some might think the aircraft has trailing link gear.

Asking prices range from \$4 million for early 2008 models to \$6 million for late 2012 models, but the market is soft, especially because of fierce competition in the midsize segment.

The Citation XLS+ and Sovereign, Learjet 60XR and Gulfstream G150 all have strong points and shortcomings. Hawker 900XP offers top notch cabin comfort, plus unmatched 2,750+ nm range with all seats occupied, along with competitive runway performance. So, it remains in a niche where it cannot be displaced. **BCA**



TEXTION

AIRCRAFT LIGHTING INT'L

PRESENTS

L5800 LED SYSTEM WITH DIMMER FOR G200's, G450's, & G550's



SEE US AT MRO LONDON • Oct. 15-17 • STAND 1301
& NBAA-BACE • Oct. 22-24 • BOOTH C11140

Bombardier CL600	Learjet 31	DC-9	Bombardier CL604	Hawker 850XP
Sabreliners			G550	Boeing 727
Learjet 36	Cessna 560XL		Cessna 525A	Learjet 25
S-76A	Astra SPX		Cessna 551	Cessna 552
Hawker 800	G450			Pilatus PC-12
EMB 120	Falcon 2000			Global Express
Hawker 1000	Learjet 45			Falcon 900
1125 Westwind				Hawker 700
Cessna 550	GV			Learjet 55
Learjet 35				Gulfstream 100
Gulfstream 200				SAAB 340
				Hawker 900XP
				Cessna 560
				Falcon 50
Bombardier CL601	G III	Cessna 750	G IV	Westwind 1124
				Hawker 600
				Beechcraft 400A

ALI-USA FAA-PMA ISO 9001:2015 AS9100D

PMA APPROVED LED LAMPS FOR THESE AIRCRAFT

TEL: (631) 474-2254 • sales@aircraftlighting.com • WWW.AIRCRAFTLIGHTING.COM

Edited by **Jessica A. Salerno** jessica.salerno@informa.com

News of promotions, appointments and honors involving professionals within the business aviation community

► **Air Charter Safety Foundation**, Washington, D.C., elected **Robert Ruffli**, vice president of Flight Operations and Director of Operations for Pentastar Aviation, vice chairman of the ACSF. In this role Ruffli will help the ACSF's mission to lead and support the advancement of the highest safety standards available to allow the business, charter and fractional ownership industry to offer the safest air transportation products and provide objective information about these standards and services to the public.



KRISTINE O'BRIEN

► **Airlines for America (A4A)**, Washington, D.C., announced that **Kristine O'Brien** has been named vice president, Global Government Affairs responsible for advancing advocacy priorities on behalf of A4A's carrier members as well as the flying and shipping public.



PAUL ROSE

► **Banyan**, Fort Lauderdale, Florida, has announced that **Paul Rose** has returned to the company after a three-year tour with Embraer Executive Jets. He rejoins Banyan as vice president of Technical Sales, a role he previously held with Banyan for over 14 years.



MORGAN LITTELL

► **Cadence Aerospace**, Anaheim, California, appointed **Anthony (Tony) E. Lawson** as vice president, Operations, Quality and Environment, Health and Safety. He will provide leadership and strategic direction for the Cadence Quality Management System, EHS initiatives, among other responsibilities.

► **Dallas Aeronautical Services**, Cedar Hill, Texas, announced that Mike Ward joined DAS/Flite as vice president of sales, parts, and component repair. He has more than 25 years of aviation experience, formerly serving as senior general manager for Spirit AeroSystems, director/GM for Hawker Beechcraft Service, and Textron Aviation Services.

► **Dassault Aviation**, Merignac, France, named **Valérie Guillemet** head of human resources, becoming the first female member to sit on the company's executive committee. Guillemet, who joined Dassault Aviation as an aerodynamics engineer in 1988, led the Rafale and Falcon series systems department, the Rafale production line, and then the Falcon 7X and 8X line before becoming deputy manager in charge of production, and, most recently, Mérignac site manager.

► **Embraer Executive Jets** appointed **Pedro Paiva** director of sales for Western and Southern Europe, based in Amsterdam. Paiva joined Embraer in 2002 and has since led several different

customer services teams, as well as played a role in the creation of the Embraer Executive Jets brand.

► **Equity Bank**, Wichita, Kansas, named **Morgan Littell** vice president, Business Aviation, responsible for establishing its Aircraft Financing Division.



RICK MADARASZ

► **FlightSafety International**, New York, New York, announced that **Rick Madarasz** has been promoted to treasurer and chief financial responsible for cash management, credit and collections, invoicing and disbursements. **Michael Burger** has been promoted to manager of the company's Learning Center in Teterboro, New Jersey. He assumes this responsibility from **Danny Robayo** who was recently promoted to vice president. Burger joined FSI in 2004 as an instructor at the Farnborough Learning Center.



MICHAEL BURGER

► **Guardian Jet** promoted **Samantha Langen** to Midwest sales director, overseeing aircraft sales, acquisitions, and consulting services in Michigan, Illinois, Indiana, and Wisconsin. Langen formerly was an inside sales manager for Guardian Jet and also has served as a senior global marketing coordinator for Clariant.



GRISCHA SCHMIDT

► **Helicopter Association International**, Washington, D.C., announced that **John Shea** joined the association as director of government affairs. Shea formerly served as director for government relations and interim president for the National Association of State Aviation Officials.



BOB GRAHAM

► **Jet Aviation**, Basel, Switzerland, announced the **Grischa Schmidt** has been appointed the new senior director Design Studio. Schmidt joined the company in 2009 as senior designer project manager. He left in 2012 and later returned as senior project manager interior designer in 2017.



BEN GRIFFIN

► **JET Infrastructure** Denver, Colorado, announced that **Chad Edinger** has joined the company as general manager.

► **London Biggin Hill**, United Kingdom, appointed its first operations director, **Bob Graham**, formerly operations director of Birmingham Airport.

► **Meridian**, Teterboro, New Jersey, announced that **Emil Iannone** has been promoted to chief operating officer at Meridian Air

If you would like to submit news of hires, promotions, appointments or awards for possible publication in On Duty, send email to jessica.salerno@informa.com or call (520) 638-8721.

Charter in Teterboro. Iannone has served as Meridian's director of operations since 2013. He started flying in the mid-1980s at TEB before attending American Flyers Academy. After graduating and earning his CFI, he returned to Meridian as an instructor pilot, moving up the ranks to Chief Pilot. In 1994, Emil was promoted to director of operations. He is type rated in a wide variety of aircraft, including Gulfstreams, Learjets and Cessna Citations.



JOAN GOODALL

► **Millennium International Avionics**, Lees Summit, Missouri, named **Todd Slater** business development director. Slater will develop commercial air transport and corporate aviation sales and service opportunities for Millennium, has held technical and leadership roles with Absolute Aviation, formerly Wencor.



EMIL IANNONE

► **PASSUR Aerospace**, Stamford, Connecticut, announced that **John Thomas**, a director of PASSUR Aerospace, has been elected executive vice chairman of the Board upon the retirement of Beck Gilbert as executive chairman of the Board. Mr. Gilbert has become non-executive chairman of the Board and continues as a director.

► **OneWeb**, McLean, Virginia, announced **Ben Griffin** has been

appointed to vice president for Commercial Aviation, leading its newly formed Commercial Aviation team.

► **Ross Aviation**, Denver, Colorado, announced the **Brian Corbett** has been named chief executive officer, and Jeff Ross has assumed the role of chairman. Both Brian and Jeff will support the network from Ross Aviation's base in Denver.

► **Skyservice Business Aviation**, Toronto, Canada, appointed **P.J. Sharpe** director of business development for the U.S. Sharpe, who will build awareness of the Skyservice brand within the U.S. market, has 22 years of aviation operations, sales, and marketing experience and most recently was senior business development manager for Skyservice.

► **TAG Aviation**, Farnborough, U.K., appointed **Joanne Goodall** as director of Customer Services for the U.K. In this newly created position Goodall will provide direction and training to the CRM and CSR teams throughout Europe and oversee strategic enhancements and opportunities for ongoing expansion in alignment with TAG's future development.

► **Traxxall**, Montreal, Canada, announced that **Roy Gioconda** joined the company as vice president of customer success. Gioconda brings 35 years of aviation experience to the newly created role at Traxxall, formerly serving as director of service quality assurance at CAMP Systems, director of maintenance at Guardian Jet and Jet Logistics, and director of quality at FlightWorks. **BCA**

20 TWENTIES

20 Twenties Nominations For 2020 Are Now Open!

The 20 Twenties program recognizes the accomplishments and drive of 20 students in their twenties who are currently enrolled in a baccalaureate or master's degree Science, Technology, Engineering or Math (STEM) programs.

Who can nominate? Only deans or faculty members may nominate students who embody the principles of Aviation Week Network's 20 Twenties.

For additional information on the program, visit aviation.informaexhibitions.com/20-20

All submissions must be received by **September 30, 2019**.
Questions? Contact carla.sands@aviationweek.com

IN ASSOCIATION WITH



Products & Services **Previews**

By Jessica A. Salerno jessica.salerno@informa.com

1. PrimeFlight Aviation Completes Deicing Rebranding

PrimeFlight Aviation Services acquired the business and assets of Ultimate Aircraft Deicing Corp. in February 2018. July marks the completion of the integration of that process. PrimeFlight's deicing team currently operates at ATL, BUF, DCA and JFK.

PrimeFlight Aviation Services
www.primeflight.com



1

regulatory approvals for both large-cabin and midsize Gulfstream aircraft. In addition, Lider, is now a Gulfstream-authorized parts dealer for South American and can facilitate parts sales transactions to support both scheduled and unscheduled maintenance events.

Gulfstream Aerospace
www.gulfstream.com

Lider Aviacao
www.lideraviacao.com.br

Aero Rio Taxi Aereo
www.aerorio.com.br

2. Gulfstream Enhances Support in Latin America

Gulfstream has added two Brazilian aircraft services companies to its worldwide list of company-authorized warranty facilities. Lider Aviacao and Aero Rio Taxi Aereo are now authorized by Gulfstream to provide warranty repairs and maintenance services within their

3



3. Air BP Expands Carbon Offset Program

Air BP has expanded its carbon offset program for business aviation in Brazil. The program will be extended to two of Voá São Paulo's airports, Jundiaí and Amarais airports are the first to join the program and there is the potential

SCHWEISS

DOORS

MANUFACTURING

HYDRAULIC "ONE-PIECE" DOORS
&
"LIFT-STRAP" BIFOLD DOORS

- Aviation
- Agricultural
- Commercial
- Industrial
- Designer

THE DOOR LEADER

507-426-8273

SCHWEISSDOORS.COM

JBT STRONGER TOGETHER **LEKTRO**

The Ultimate Aircraft Tug

Models ranging
15,000 to 280,000 lbs.

- Electric
- Towbarless
- Certified
- Universal
- Easy to Use
- Simple to Maintain
- Rugged

[www.LEKTRO.com](http://www.lektro.com)

1-800-535-8767 1-503-861-2288
sales@lektro.com

to expand the offer to more of Voa Sao Paulo's locations in the future. Air BP launched its carbo offsetting offer for business aviation in Brazil in 2018. The offset program is run via BP Target Neutral.

Air BP
www.bp.com

4



4. Meggitt Selected for Dassault Falcon 6X Systems

Meggitt PLC has been chosen by Dassault to provide the wheels, brakes, brake control system, and tire pressure monitoring system for the Falcon 6X program. The value of the contract runs for the lifetime of the program. Meggitt will also provide landing gear control computers, which will perform the control and monitoring for landing gear sequencing, nose wheel steering control and the hydraulic system.

Meggitt
www.meggitt.com

5



5. Trade-A-Plane Adds eCommerce to its Online Marketplace

The new eCommerce sections on Trade-A-Plane.com allows customers to list single items for sale, or, maintain an inventory of multiple items. Buyers can also purchase parts, avionics and other products directly from the website. All transactions are handled by PayPal for Marketplaces. "If you have something to sell, you can place a listing quickly and easily on our website and reach one of the largest audience in general aviation. Plus, the listing is free, and you only pay a small percentage fee once the item is sold," said Jon Goodwin, the new publisher of Trade-A-Plane.

Trade-A-Plane
www.trade-a-plane.com

6



6. SkyRegs Launches New Web-Based Service

SkyRegs, a web-based service that provides a single-source of aviation

safety regulations and guidance for the aviation community, was launched at the recent EAA AirVenture Air Show. Updated daily, the online service provides instant access to over 10 million pages of the latest aviation regulations and guidance. Users can type in a topic, keywords or an acronym and the program returns a list of documents organized by relevance. SkyRegs also has a browse feature and a Certification Basis tool that enable users to identify all of the regulatory changes that took place between points in time, or between Amendment levels. SkyRegs was developed by and is operated by Network Designs, Inc., a Service-Disabled Veteran Owned Small Business.

SkyRegs.com
 McLean, Virginia
SkyRegs.com

AcUKwik Page 37
acukwik.com

Air Charter Guide Page 41
aircharterguide.com

Air Charter Safety Foundation Page 29
acsf.aero/join

Aircraft Bluebook Page 63
aircraftbluebook.com

Aircraft Lighting Page 67
aircraftlighting.com

AMSTAT Page 4
www.amstatcorp.com

Aviation Week Intelligence Network Page 65
pages.aviationweek.com/intelfleetdata

Business & General Aviation Conference Page 5

Corporate Angel Network Pages 15, 17
corpangelnetwork.org

FlightSafety International Page 21
flightsafety.com

Garmin 4th Cover
garmin.com

GE Honda Aero Engines Page 10
gehonda.com

Global Business Aviation Solutions Page 9

Gulfstream 2nd Cover
gulfstream.com/connectivity

Jet Appraisals Page 54
www.aviationweek.com/ABB-jetappraisals

Lektro Page 70
lektro.com

Pilatus Page 6
www.pilatus-aircraft.com

Piper 3rd Cover
piper.com/proflight

Schweiss Page 70
www.schweissdoors.com

SmartSky Networks Page 19
smartskynetworks.com

TakeOff North America 2019 Page 61
takeoffnorthamerica.com

The Weekly of BusinessAviation Page 2
www.aviationweek.com/wba

20 Twenties Page 69

Urban Air Mobility Asia-Pacific/Europe Page 45
uamap.aviationweek.com

September 1969 News

If talk and written **verbiage** could build an ATC system, ours would be the finest, **most fault-free**, unlimited capacity ATC **contrivance ever devised by man.** – *BCA Staff*

Edited by Jessica A. Salerno jessica.salerno@informa.com

Unless we refurbish our system for the meantime, many of us may not survive, economically or physically, to be around to enjoy the Apollo-sized automated one of the future.



Interceptor 400 single engine pressurized turboprop introduced by privately owned Interceptor Corp. of Norman, Oklahoma, is scheduled for certification in late 1969. Price is estimated at \$90,000



Student-pilot insurance, first of its type, is offered now by Avemco. Plan gives \$300,000 liability coverage for non-owner student pilots age 17-24. Annual premium is \$30. Policy may be increased to \$20,000 for damage to rented aircraft.



Power Player: Sperry Flight System's ATS-500 Autothrottle System has been certified for the Grumman Gulfstream II and at least three operators have installed it. Certification covers climb-out, cruise, descent and approach flight regimes.

East Czechs In: As if they didn't have enough problems, the tormented land of Czechoslovakia has introduced a business commuter aircraft, first shown publicly in the West at Paris. PT6A powered, 17-place, and with a max gross weight of 11,280 lb., the L410 Turbolet comes described as suitable for executive, light-cargo or commuter-line applications.

BCA and its sister Ziff-Davis aviation publications will staff a message center daily at the NBAA convention center headquarters at the Washington Hilton Hotel. **BCA**



THE ARCHIVE



One of the world's largest, most modern, most controversial and, according to some, dulllest airports, Dulles International, Chantilly, Virginia, is the scene of the 1969 NBAA Convention. Photo by dean of aerial photogs, Tony Linck, from an Enstrom F-28 helicopter.



CAT-A-Last is the unequalled leader in every area of test for superior aircraft finishes. This Commodore Jet was judged best of show in its class at the 1969 Reading Air Show.

M600 | 600 HORSEPOWER. ZERO COMPROMISE.



There are aircraft that feature club seating for six. There are others that have G3000[®] avionics. And some can rival 1,658 nm range and 274 knot max speed. But have you ever seen one that gives you the whole package for \$2.92 million, or more than \$1 million less than the competition? You have now. The M600 from Piper Aircraft. Learn more with just one call to your full-service dealer today.

M-CLASS: M350 | M500 | M600

pipper.com
1.772.299.2403

Piper[®]
FREEDOM OF FLIGHT



////// G5000® FLIGHT DECK UPGRADE FOR CITATION EXCEL/XLS //////////////////////////////////

- » ZERO-TIME AVIONICS
- » LOWER OPERATING COSTS
- » SIGNIFICANT WEIGHT SAVINGS
- » ADS-B/DATA COMM AND MORE
- » AUTOMATICALLY ACTIVATED EMERGENCY DESCENT MODE
- » SURFACEWATCH™ SURFACE MONITORING AND ALERTING TECHNOLOGY
- «

For more information, visit Garmin.com/XLS